

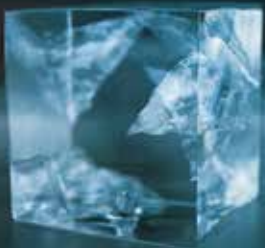

# HOSHIZAKI

LEADING NATURALLY

CATALOGUE  
2023





# HOSHIZAKI

LEADING NATURALLY

We are pursuing a growth objective at Hoshizaki Corporation that contributes to the evolution of the communities in which we operate, as well as the satisfaction of customers who use our products.

We strive to meet the increasingly stringent demands of the world catering and food distribution.

To achieve this, we develop original products that incorporate technologies innovative, and we present ourselves with proposals that allow the preparation of food and drinks for a healthier, more varied and tasty food consumption, in environments comfortable, made possible through equipment with low environmental impact and absolute quality and sustainability.

**2 YEAR  
WARRANTY**  
PARTS &  
LABOR\*

\* Country-by-country agreement



**Hoshizaki, in Europe, is present with 10 branch offices in key markets, coordinating a vast number of authorized dealers and service agents.**

**Equipment is assembled in the United Kingdom, or received as finished product from one of our global manufacturing locations.**

**Our main equipment distribution center is in The Netherlands, while we run our spare parts and a technical training centers in multiple locations.**

**With over 70 years of experience in the field of commercial refrigeration equipment, Hoshizaki is now internationally recognized for sustainable innovation, durability and reliability of its products.**



# HOSHIZAKI

LEADING NATURALLY

## Higher density and lower temperature

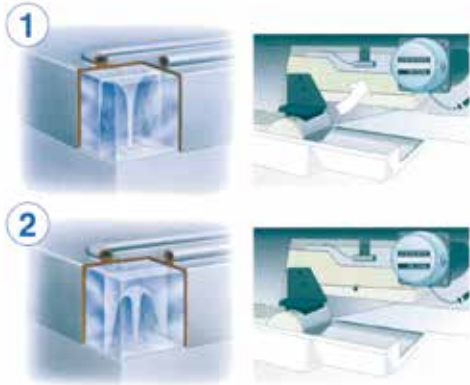

Thanks to the Hoshizaki "closed cell" technology Hoshizaki ice cubes are formed by injecting a stream of water free from air bubbles on the evaporator surface.

The injectors of the Hoshizaki system are located along the upper surface of a tilting platform: in the closed position, the platform becomes the sixth (and base-side) of the cells in which the cubes are formed, the only non-freezing one. This proximity allows water to be injected, not sprayed. Pure water molecules, free from air, aggregate tightly while freezing, **giving origin to a high-density ice quality.**

### Sub-freezing temperature

All of the freezing temperatures generated by the refrigeration system remain trapped within the five sides of the evaporator and the base-side of the platform in its closed position, without dispersion. Ice can then be brought to temperatures below freezing.

Subcooling leads to "**marbling**", the formation of unique hairline cracks within the ice cubes, generated by the compression of freezing water attempting to expand within the cell.

The "Marble Effect" vanishes as the ice comes into contact with the warmer temperature of the drink.

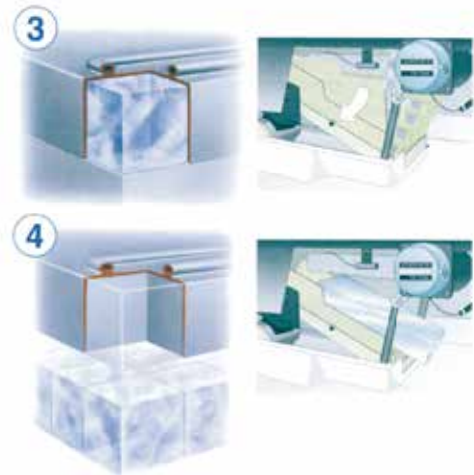

### Reduced heat exchange surface for longer-lasting flavour

Sharp edged ice cubes, finally the "classic" shape of cube, or perfect cube, depending on the formats, without internal cavities (a minimum trace of the point of impact of the water with the forming ice remains), Hoshizaki cubes offer, at a given volume, a lower heat exchange surface than thimble-shaped cubes, leading to a slower melt rate and extending the most flavorful part of the drink experience!

**The above are the reasons why the Hoshizaki cubes have established themselves in the trendiest cocktail bars and drink venues around the world.**



**The ice cube  
that cools  
the most  
and dilutes  
the least**

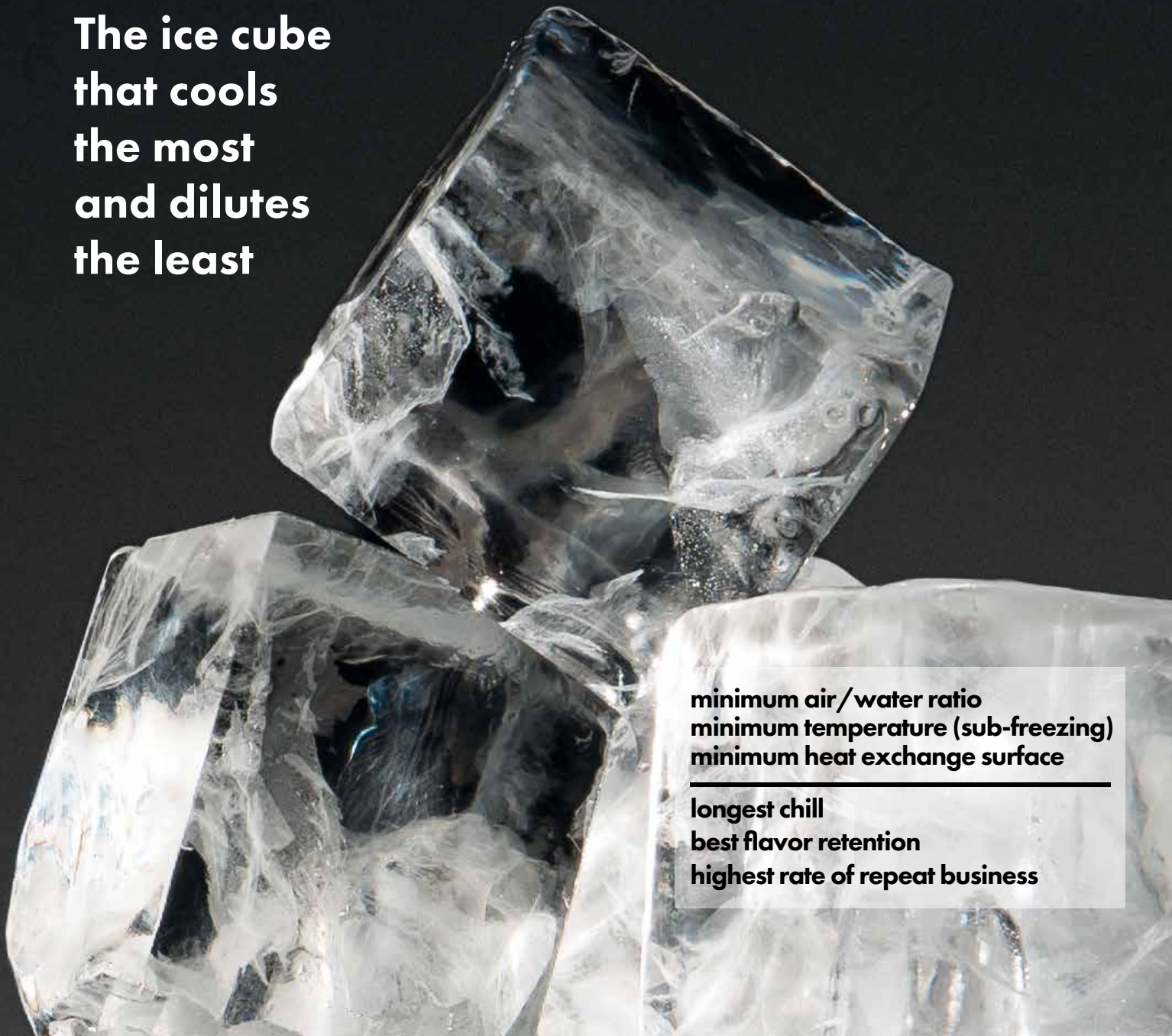

**minimum air/water ratio  
minimum temperature (sub-freezing)  
minimum heat exchange surface**

---

**longest chill  
best flavor retention  
highest rate of repeat business**

## **Simply spectacular!**

An incomparable performance thanks to greater ice density; transparency blended with character (unique "marble effect", achieved through subcooling); geometrically pure (prismatic or cubic) forms, with 90 degrees corners; distinguished dimensions, with the best-in-class heat exchange surface (no internal cavities!).

**The result: an unmistakably captivating identity!**

These are fundamental aspects to guarantee the best visual and organoleptic quality of the drink. Take your time, it's Hoshizaki Ice!

**Extended drink-time offered by Hoshizaki.  
Appreciated by patrons in the best cocktail-bars around  
the world.**



# Hoshizaki Exclusive Ice Cubes: Shapes and Sizes

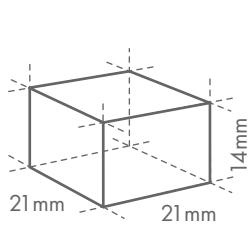

"XS" Cube  
Extra Small approx. 6 g  
Size code: - 21

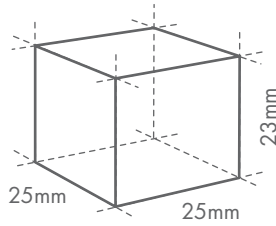

"S" Cube  
Small approx. 13 g  
Size code: - 25

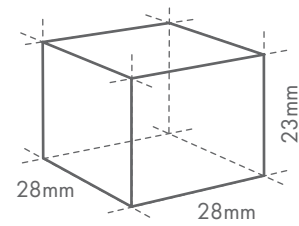

"M" Cube  
Medium approx. 17 g  
Size code: - 23

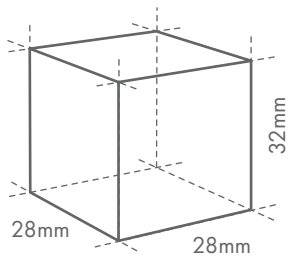

"L" Cube  
Large approx. 23 g  
Standard Cube

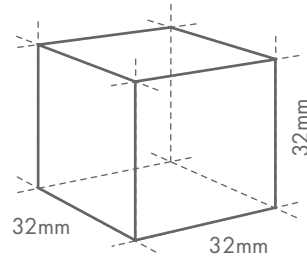

"XL" Cube  
Extra Large approx. 31 g  
Size code: - 32

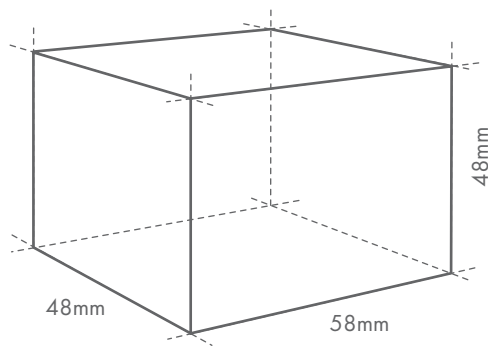

"XXL" Cube  
Extra Extra Large approx. 120 g  
Size code: LM  
Model: IM-65 NE (HC)-LM



# HOSHIZAKI

LEADING NATURALLY

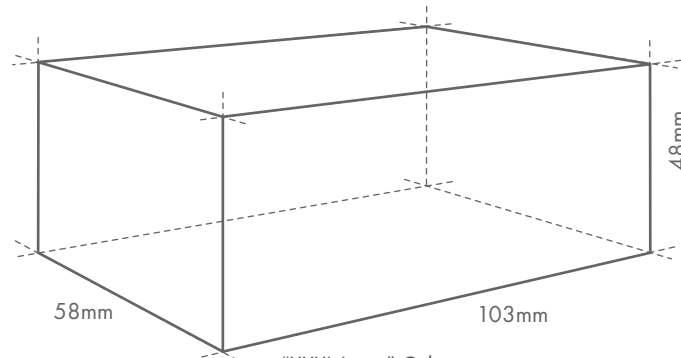

"XXXL Long" Cube  
Extra Extra Extra Large approx. 240 g  
Model IM-65 NE-(HC) - LM103

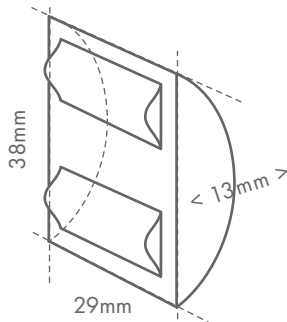

Crescent Cube approx. 9 g  
Model KM

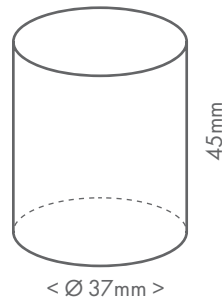

Cylinder Cube approx. 42 g  
Model IM-65 NE-(HC)-C or IM-100 NE-C

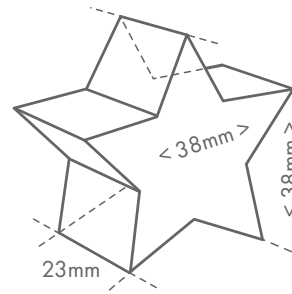

Star Cube approx. 18 g  
Model IM-65 NE-(HC)-S

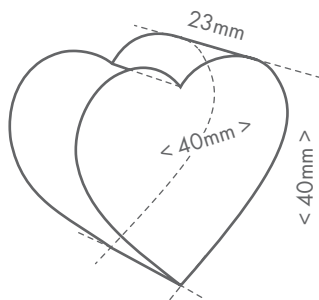

Heart Cube approx. 25 g  
Model IM-65 NE-(HC)-H

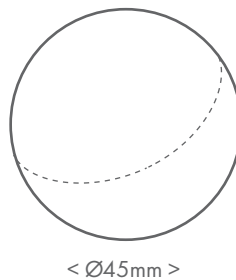

Ball Cube approx. 45 g  
Model IM-65 NE-(HC)-Q

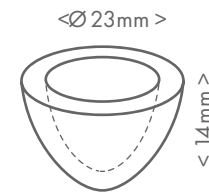

Shuttle Cube approx. 3 g  
Model DSM-12-DE



# IM Range

Ecological ice makers for  
IM Cubes with built-in  
container and separate  
ice container



## IM-21 CNE-HC with built-in container

Net dimensions (mm)	398 x 451 x 695
Ice Storage capacity up to (kg)	11,5
Crated dimensions (mm)	505 x 575 x 862
Crated Volume (m <sup>3</sup> )	0,25
Refrigerant	R290



Large Cube mm 28 x 28 x 32

Model	Ice cube type	Condenser	Production up to kg (24h) air 10°C / water 10°C	Production up to kg (24h) air 21°C / water 15°C	Electrical specs V/Hz/Ph	Power rating (W)	Net weight / gross (kg)	ITEM
IM-21 CNE-HC	Large	Air	25	24	220-240/50/1	225	34/39	M061

## IM-30 CNE-HC with built-in container

Net dimensions (mm)	398 x 451 x 695 (legs + 90 -125)
Ice Storage capacity up to (kg)	11,5
Crated dimensions (mm)	505 x 575 x 862
Crated Volume (m <sup>3</sup> )	0,25
Refrigerant	R290



Large Cube mm 28 x 28 x 32  
Small Cube mm 25 x 25 x 23

Model	Ice cube type	Condenser	Production up to kg (24h) air 10°C / water 10°C	Production up to kg (24h) air 21°C / water 15°C	Electrical specs V/Hz/Ph	Power rating (W)	Net weight / gross (kg)	ITEM
IM-30 CNE-HC	Large	Air	30	26	220-240/50/1	230	34/39	M062
IM-30 CNE-HC-25	Small	Air	25	23	220-240/50/1	230	34/39	M062-D001
IM-30 CWNE-HC	Large	Water	30	28	220-240/50/1	190	35/41	M062-D002
IM-30 CWNE-HC-25	Small	Water	24	22	220-240/50/1	190	35/41	M062-D003

## IM-45 CNE-HC with built-in container

Net dimensions (mm)	633 x 511 x 690 (legs + 90 -125)
Ice Storage capacity up to (kg)	15
Crated dimensions (mm)	735 x 570 x 864
Crated Volume (m <sup>3</sup> )	0,36
Refrigerant	R290



Large Cube mm 28 x 28 x 32  
Small Cube mm 25 x 25 x 23

Model	Ice cube type	Condenser	Production up to kg (24h) air 10°C / water 10°C	Production up to kg (24h) air 21°C / water 15°C	Electrical specs V/Hz/Ph	Power rating (W)	Net weight / gross (kg)	ITEM
IM-45 CNE-HC	Large	Air	46	42	220-240/50/1	275	45/55	M065
IM-45 CNE-HC-25	Small	Air	39	35	220-240/50/1	275	45/55	M065-D001

## IM-45 NE-HC with built-in container

Net dimensions (mm)	503 x 456 x 840 (legs + 90 -125)
Ice Storage capacity up to (kg)	18
Crated dimensions (mm)	635 x 520 x 1007
Crated Volume (m <sup>3</sup> )	0,33
Refrigerant	R290



Large Cube mm 28 x 28 x 32  
Small Cube mm 25 x 25 x 23

Model	Ice cube type	Condenser	Production up to kg (24h) air 10°C / water 10°C	Production up to kg (24h) air 21°C / water 15°C	Electrical specs V/Hz/Ph	Power rating (W)	Net weight / gross (kg)	ITEM
IM-45 NE-HC	Large	Air	46	42	220-240/50/1	275	44/50	M064
IM-45 NE-HC-25	Small	Air	39	35	220-240/50/1	275	44/50	M064-D001
IM-45 WNE-HC	Large	Water	45	40	220-240/50/1	240	45/53	M064-D002
IM-45 WNE-HC-25	Small	Water	42	38	220-240/50/1	IVD	45/53	M064-D003



# IM Range

Ecological ice makers for IM cubes with built-in container



## IM-65 NE-HC with built-in container

Net dimensions (mm)	633 x 506 x 840 (legs + 90 -125)
Ice Storage capacity up to (kg)	26
Crated dimensions (mm)	735 x 570 x 1012
Crated Volume (m <sup>3</sup> )	0,42
Refrigerant	R290



Large Cube mm 28 x 28 x 32  
Small Cube mm 25 x 25 x 23

Model	Ice cube type	Condenser	Production up to kg (24h) air 10°C / water 10°C	Production up to kg (24h) air 21°C / water 15°C	Electrical specs V/Hz/Ph	Power rating (W)	Net weight / gross (kg)	ITEM
IM-65 NE-HC	Large	Air	62	56	220-240/50/1	320	50/60	M066
IM-65 NE-HC-25	Small	Air	56	49	220-240/50/1	330	50/60	M066-D001
IM-65 WNE-HC	Large	Water	60	55	220-240/50/1	300	53/63	M066-D013
IM-65 WNE-HC-25	Small	Water	TBA	TBA	220-240/50/1	IVD	IVD	M066-D014

## IM-100 CNE-HC with built-in container

Net dimensions (mm)	1004 x 600 x 800 (legs + 70-100)
Container capacity up to (kg)	38
Size with packaging (mm)	1110 x 700 x 875
Crated Volume (m <sup>3</sup> )	0,68
Refrigerant	R290



Extra Large Cube mm 32 x 32 x 32  
Large Cube mm 28 x 28 x 32  
Medium Cube mm 28 x 28 x 23  
Extra small Cube mm 21 x 21 x 14

Model	Ice cube type	Condenser	Production up to kg (24h) air 10°C / water 10°C	Production up to kg (24h) air 21°C / water 15°C	Electrical specs V/Hz/Ph	Power rating (W)	Net weight / gross (kg)	ITEM
IM-100CNE-HC-32	Extra large	Air	100	93	220-240/50/1	500	77/88	M068-D002
IM-100 CNE-HC	Large	Air	105	95	220-240/50/1	500	77/88	M068
IM-100CNE-HC-23	Medium	Air	79	77	220-240/50/1	500	77/88	M068-001
IM-100CNE-HC-21	Extra small	Air	90	85	220-240/50/1	500	77/88	M068-D003

## IM-100 NE-HC with built-in container

Net dimensions (mm)	704 x 506 x 1200 (legs + 70 - 100)
Ice Storage capacity up to (kg)	50
Crated dimensions (mm)	805 x 580 x 1375
Crated Volume (m <sup>3</sup> )	0,64
Refrigerant	R290



Extra Large Cube mm 32 x 32 x 32  
Large Cube mm 28 x 28 x 32  
Medium Cube mm 28 x 28 x 23  
Extra small Cube mm 21 x 21 x 14

Model	Ice cube type	Condenser	Production up to kg (24h) air 10°C / water 10°C	Production up to kg (24h) air 21°C / water 15°C	Electrical specs V/Hz/Ph	Power rating (W)	Net weight / gross (kg)	ITEM
IM-100 NE-HC-32	Extra large	Air	94	84	220-240/50/1	500	76/84	M036-D002
IM-100 NE-HC	Large	Air	105	95	220-240/50/1	555	76/84	M036
IM-100 NE-HC-23	Medium	Air	85	83	220-240/50/1	520	76/84	M036-D001
IM-100 NE-HC-21	Extra small	Air	90	85	220-240/50/1	555	76/84	M036-D003
IM-100 WNE-HC	Large	Water	90	85	220-240/50/1	465	74/84	M036-D004
IM-100 WNE-HC-23	Medium	Water	85	80	220-240/50/1	465	74/84	M036-D005
IM-100 WNE-HC-21	Extra small	Water	95	85	220-240/50/1	465	74/84	M036-D006

## DRAIN PUMP KIT Sauermann® Si-83 Pack 1

Net dimensions (mm)	287 x 146 x 129
Crated dimensions (mm)	315 x 151 x 175
Crated Volume (m <sup>3</sup> )	0.008

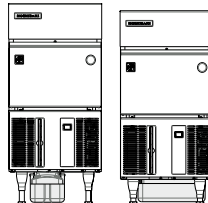

External drain pump	Max flow rate (ltr. per hr.)	Tank capacity (ltr.)	Max discharge head (m)	Max pressure (flow rate 0) (m)	Electrical specs V/Hz/Ph	Power rating (W)	Net weight / gross (kg)	ITEM
Sauermann® Si-83 Pack 1	700	2	5.4 (65 l/h)	5.7	220-240/50/1	115	2.3/2.9	S-32904

COMPATIBLE WITH SELF CONTAINED ICE MACHINE MODELS: IM-21 ALL VERSIONS (1) - IM-30 ALL VERSIONS (1) - IM-45 ALL VERSIONS (1) - IM-65 ALL VERSIONS (2)





# IM Range

Ecological ice makers for IM cubes with built-in and separate container



## IM-130 NE-HC with built-in container

Net dimensions (mm)	704 x 506 x 1200 (legs + 70 - 100)
Ice Storage capacity up to (kg)	50
Crated dimensions (mm)	805 x 580 x 1375
Crated Volume (m <sup>3</sup> )	0,64
Refrigerant	R290



Extra Large Cube mm 32 x 32 x 32  
Large Cube mm 28 x 28 x 32  
Medium Cube mm 28 x 28 x 23  
Extra small Cube mm 21 x 21 x 14

Model	Ice cube type	Condenser	Production up to kg (24h) air 10°C / water 10°C	Production up to kg (24h) air 21°C / water 15°C	Electrical specs V/Hz/Ph	Power rating (W)	Net weight / gross (kg)	ITEM
IM-130NE-HC-32	Extra large	Air	100	95	220-240/50/1	615	76/85	M069-D003
IM-130 NE-HC	Large	Air	125	112	220-240/50/1	615	76/85	M069
IM-130NE-HC-23	Medium	Air	100	90	220-240/50/1	615	76/85	M069-D001
IM-130NE-HC-21	Extra small	Air	105	95	220-240/50/1	615	76/85	M069-D002
IM-130 WNE-HC	Large	Water	100	90	220-240/50/1	550	74/84	M069-D004
IM-130WNE-HC-23	Medium	Water	90	85	220-240/50/1	550	74/84	M069-D005

## IM-240 NE-HC with built-in container

Net dimensions (mm)	704 x 506 x 1200 (legs + 70 - 100)
Ice Storage capacity up to (kg)	100
Crated dimensions (mm)	805 x 580 x 1375
Crated Volume (m <sup>3</sup> )	0,64
Refrigerant	R290



Extra Large Cube mm 32 x 32 x 32  
Large Cube mm 28 x 28 x 32  
Medium Cube mm 28 x 28 x 23  
Extra small Cube mm 21 x 21 x 14

Model	Ice cube type	Condenser	Production up to kg (24h) air 10°C / water 10°C	Production up to kg (24h) air 21°C / water 15°C	Electrical specs V/Hz/Ph	Power rating (W)	Net weight / gross (kg)	ITEM
IM-240 NE-HC	Large	Air	210	195	220-240/50/1	930	107/120	M070
IM-240 NE-HC-23	Medium	Air	180	175	220-240/50/1	930	107/120	M070-D001
IM-240 NE-HC-21	Extra small	Air	185	165	220-240/50/1	930	107/120	M070-D002
IM-240 WNE-HC	Large	Water	207	193	220-240/50/1	810	103/118	M070-D003
IM-240 WNE-HC-23	Medium	Water	190	175	220-240/50/1	810	103/118	M070-D004

## IM-130 ANE - HC with separate container

Net dimensions (mm)	560 x 700 x 880
Corresponding Bins (+possible top kits)	B - 140 SA B - 210 SA (TK 8 D) B - 340 SA (1xTK 8 D, 1xTK 18 D)
Crated dimensions (mm) IM-130 ANE-HC	820 x 665 x 1054 940 x 760 x 1190
Crated Volume (m <sup>3</sup> ) IM-130 ANE-HC Storage Bin B - 140 SA	0,57 0,75
Crated weight (kg) B - 140 SA	49
Refrigerant	R290



IM-130 ANE - HC  
+ B - 140 SA  
(sold separately)



Large Cube mm 28 x 28 x 32  
Small Cube mm 25 x 25 x 23

Model	Ice cube type	Condenser	Production up to kg (24h) air 10°C / water 10°C	Production up to kg (24h) air 21°C / water 15°C	Electrical specs V/Hz/Ph	Power rating (W)	Net weight / gross (kg)	ITEM
IM-130 ANE-HC*	Large	Air	125	110	220-240/50/1	635	68/79	M037-D100
IM-130ANE-HC-23*	Medium	Air	100	95	220-240/50/1	635	68/79	M037-D101

\*50 Hz model with stainless steel frame

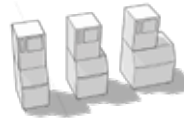

IM-130 ANE-HC on B-140 SA / B-210 SA / B-340 SA



# IM Range

Ecological ice makers for IM cubes with separate container



## IM-240 ANE - HC with separate container

Net dimensions (mm)	560 x 700 x 880
Corresponding Bins (+possible top kits)	B - 140 SA B - 210 SA (TK 8 D) B - 340SA (1xTK 8D-1xTK 18D)
Crated dimensions (mm) IM-240 ANE-HC Storage Bin B - 301 SA	665 x 820 x 1054 940 x 760 x 1190
Crated Volume (m <sup>3</sup> ) IM-240 ANE-HC Storage Bin B - 140 SA	0,57 0,75
Crated weight (kg) B - 140 SA	49
Refrigerant	R290



IM-240 ANE - HC  
+ B - 140 SA  
(sold separately)



Extra large Cube mm 32 x 32 x 32  
Large Cube mm 28 x 28 x 32  
Medium Cube mm 28 x 28 x 23  
Extra small Cube mm 21 x 21 x 14

Model	Ice cube type	Condenser	Production up to kg (24h) air 10°C / water 10°C	Production up to kg (24h) air 21°C / water 15°C	Electrical specs V/Hz/Ph	Power rating (W)	Net weight / gross (kg)	ITEM
IM-240 ANE-HC-32	Extra large	Air	220	200	220-240/50/1	930	78/89	E1GA-D102
IM-240 ANE-HC	Large	Air	210	195	220-240/50/1	870	78/89	E1GA-D100
IM-240 ANE-HC-23	Medium	Air	190	170	220-240/50/1	860	78/89	E1GA-D101
IM-240 ANE-HC-21	Extra small	Air	210	200	220-240/50/1	930	78/89	E1GA-D103
IM-240 AWNE-HC*	Large	Water	205	190	220-240/50/1	800	76/89	E1GA-D106
IM-240 AWNE-HC-21*	Extra small	Water	TBA	TBA	220-240/50/1	TBA	TBA	E1GA-D108
IM-240 AWNE-HC-23*	Medium	Water	170	155	220-240/50/1	800	74/86	E1GA-D117

\* 50 Hz model with stainless steel frame

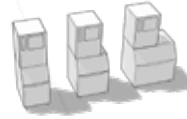

IM-240 ANE-HC on B-140 SA / B-210 SA / B-340 SA

## IM-240 DNE - HC / IM 240 XNE - HC with separate container

Net dimensions (mm)	1084 x 700 x 500
Corresponding Bins (+possible top kits)	B - 340SA (TK IM D2) F 650 - 42 S F 650 - 44S F 950 - 48 S F 1025 - 52 S
Crated dimensions (mm) - IM-240 DNE-HC Storage Bin B - 340 SA	1196 x 825 x 640 1328 x 928 x 1194
Crated Volume (m <sup>3</sup> ) IM-240 DNE-HC Storage Bin B - 340 SA	0,63 1,5
Crated weight (kg) B - 340 SA	88
Refrigerant	R290



IM-240 DNE-HC  
+ B - 340 SA (sold separately)



Extra large Cube mm 32 x 32 x 32  
Large Cube mm 28 x 28 x 32  
Medium Cube mm 28 x 28 x 23  
Extra small Cube mm 21 x 21 x 14

Model	Ice cube type	Condenser	Production up to kg (24h) air 10°C / water 10°C	Production up to kg (24h) air 21°C / water 15°C	Electrical specs V/Hz/Ph	Power rating (W)	Net weight / gross (kg)	ITEM
IM-240 DNE-HC-32	Extra large	Air	190	175	220-240/50/1	930	82/96	M071-D103
IM-240 XNE-HC-32	Extra large	Air	190	175	220-240/50/1	930	78/93	M071-D105
IM-240 DNE-HC	Large	Air	210	195	220-240/50/1	930	82/96	M071-D100
IM-240 XNE-HC	Large	Air	210	195	220-240/50/1	930	78/93	M071-D101
IM-240 DNE-HC-23	Medium	Air	180	175	220-240/50/1	930	82/96	M071-D102
IM-240 XNE-HC-23	Medium	Air	180	175	220-240/50/1	930	78/93	M071-D104
IM-240 DNE-HC-21	Extra small	Air	205	195	220-240/50/1	975	82/96	M071-D106
IM-240 XNE-HC-21	Extra small	Air	205	185	220-240/50/1	930	78/93	M071-D107
IM-240 DWNE-HC-32	Extra large	Water	190	175	220-240/50/1	835	79/93	M071-D114
IM-240 DWNE-HC	Large	Water	209	196	220-240/50/1	835	80/94	M071-D108
IM-240 DWNE-HC-23	Medium	Water	190	170	220-240/50/1	835	78/92	M071-D110
IM-240 DWNE-HC-21	Extra small	Water	205	190	220-240/50/1	835	78/92	M071-D112
IM-240 XWNE-HC-32	Extra large	Water	190	175	220-240/50/1	835	75/89	M071-D115
IM-240 XWNE-HC*	Large	Water	209	196	220-240/50/1	835	76/90	M071-D109
IM-240 XWNE-HC-23*	Medium	Water	190	170	220-240/50/1	835	74/88	M071-D111
IM-240 XWNE-HC-21*	Extra small	Water	205	190	220-240/50/1	835	74/88	M071-D113



IM-240 DNE-HC - Basic model with top panel  
IM-240 XNE-HC - Stackable model with conveyor kit  
IM-240 XNE-HC - Stackable model with conveyor kit



# IM Range Special Cube



Ecological ice makers  
for IM cubes with  
built-in container



## IM-65 NE-HC Q / LM / LM Big Shot / LM103 with built-in container

<b>Net dimensions (mm)</b>	633 x 506 x 860 (legs + 90 - 125)
<b>Ice Storage capacity up to (kg)</b>	17-model Q 26-model LM 26-model LM 103
<b>Crated dimensions (mm)</b>	735 x 570 x 1012
<b>Crated Volume (m<sup>3</sup>)</b>	0,33
<b>Refrigerant</b>	R290



### Ball Cube Ø 45 mm

Model	Ice cube type	Condenser	Production up to kg (24h) air 10°C / water 10°C	Production up to kg (24h) air 21°C / water 15°C	Electrical specs V/Hz/Ph	Power rating (W)	Net weight / gross (kg)	ITEM
IM-65 NE-HC Q "Ball"	Ball	Air	28 (622 cubes)	26 (577 cubes)	220-240/50/1	320	53/66	M066-D012
IM-65 WNE-HC Q "Ball"	Ball	Water	24 (533 cubes)	22 (488 cubes)	220-240/50/1	300	55/64	M066-D015



### XXL Big Cube mm 48 x 58 x 48

Model	Ice cube type	Condenser	Production up to kg (24h) air 10°C / water 10°C	Production up to kg (24h) air 21°C / water 15°C	Electrical specs V/Hz/Ph	Power rating (W)	Net weight / gross (kg)	ITEM
IM-65 NE-HC LM "Big"	XXL Big	Air	43 (358 cubes)	35 (291 cubes)	220-240/50/1	320	51/61	M066-D009



### XXXL Long Cube mm 58 x 103 x 48

Model	Ice cube type	Condenser	Production up to kg (24h) air 10°C / water 10°C	Production up to kg (24h) air 21°C / water 15°C	Electrical specs V/Hz/Ph	Power rating (W)	Net weight / gross (kg)	ITEM
IM-65NE-HC LM 103 "Long"	XXXL Long	Air	39 (162 cubes)	32 (133 cubes)	220-240/50/1	400	53/61	M066-D010

## IM-65 NE - HC H / S with built-in container

<b>Net dimensions (mm)</b>	633 x 506 x 860 (legs + 90 - 125)
<b>Ice Storage capacity up to (kg)</b>	26
<b>Crated dimensions (mm)</b>	735 x 570 x 1012
<b>Crated Volume (m<sup>3</sup>)</b>	0,33
<b>Refrigerant</b>	R290



### Heart Cube mm 40 x 23 x 40



### Star Cube mm 38 x 23 x 38

Model	Ice cube type	Condenser	Production up to kg (24h) air 10°C / water 10°C	Production up to kg (24h) air 21°C / water 15°C	Electrical specs V/Hz/Ph	Power rating (W)	Net weight / gross (kg)	ITEM
IM-65 NE-HC H "Heart"	Heart	Air	33 (1320 cubes)	29 (1160 cubes)	220-240/50/1	400	53/61	M066-D007
IM-65 NE-HC S "Star"	Star	Air	20 (1110 cubes)	20 (1110 cubes)	220-240/50/1	320	51/61	M066-D008

# IM Range Cylinder Cubes

Ecological ice makers  
for IM cubes with built-in  
and separate container



## IM-65 NE HC - C with built-in container

Net dimensions (mm)	633 x 506 x 860 (legs + 90 -125)
Ice Storage capacity up to (kg)	26
Crated dimensions (mm)	735 x 570 x 1012
Crated Volume (m <sup>3</sup> )	0,42
Refrigerant	R290



Cylinder Cube Ø 37 x 45 mm

Model	Ice cube type	Condenser	Production up to kg (24h) air 10°C / water 10°C	Production up to kg (24h) air 21°C / water 15°C	Electrical specs V/Hz/Ph	Power rating (W)	Net weight / gross (kg)	ITEM
IM-65 NE -HC -C "Cylinder"	Cylinder	Air	55 (1309 cubes)	45 (1071 cubes)	220-240/50/1	320	51/61	M066-D011

## IM-100 NE HC - C with built-in container

Net dimensions (mm)	704 x 506 x 1200 (legs + 70 -110)
Ice Storage capacity up to (kg)	26
Crated dimensions (mm)	805 x 580 x 1375
Crated Volume (m <sup>3</sup> )	0,42
Refrigerant	R290



Cylinder Cube Ø 37 x 45 mm

Model	Ice cube type	Condenser	Production up to kg (24h) air 10°C / water 10°C	Production up to kg (24h) air 21°C / water 15°C	Electrical specs V/Hz/Ph	Power rating (W)	Net weight / gross (kg)	ITEM
IM-100 NE -HC -C "Cylinder"	Cylinder	Air	90 (2142 cubes)	80 (1904 cubes)	220-240/50/1	490	80/91	M036-D010

## IM-240 DNE - HC-C / XNE - HC - C with separate container

Net dimensions	1084 x 700 x 500
Corresponding Bins (+possible top kits)	B - 340 SA (1xTK IM D2) F 650 - 42 S F 650 - 44 S F 950 - 48 S
Crated dimensions (mm)	IM-240 DNE-C /XNE-C Storage bin B - 340 SA 1196 x 825 x 640 1328 x 928 x 1194
Crated Volume (m <sup>3</sup> )	IM-240 DNE-C / XNE-C B - 340 SA 0,63 1,5
Crated weigh (kg)	B - 801 SA 88
Refrigerant	R290



IM-240 DNE-C installato su contenitore B - 340 SA (venduto separatamente)



Cylinder Cube Ø 37 x 45 mm

Model	Ice cube type	Condenser	Production up to kg (24h) air 10°C / water 10°C	Production up to kg (24h) air 21°C / water 15°C	Electrical specs V/Hz/Ph	Power rating (W)	Net weight / gross (kg)	ITEM
IM-240 DNE -HC-C "Cylinder"	Cylinder	Air	190 (4523 cubes)	185 (4404 cubes)	220-240/50/1	930	85/99	M071-D122
IM-240DWNE-HC-C* "Cylinder"	Cylinder	Water	205 (4880 cubes)	185 (4404 cubes)	220-240/50/1	835	84/96	M071D124
IM-240 XNE -HC-C "Cylinder"	Cylinder	Air	190 (4523 cubes)	185 (4404 cubes)	220-240/50/1	930	85/99	M071-D123
IM-240XWNE-HC-C "Cylinder"	Cylinder	Water	205 (4880 cubes)	185 (4404 cubes)	220-240/50/1	835	80/92	M071-D125



IM-240 DNE-HC-C - Basic model with top panel  
IM-240 XNE-HC-C - Stackable model with conveyor kit  
IM-240 XNE-HC-C - Stackable model with conveyor kit

B-340 SA

# IM Range Cylinder Cubes

Ecological ice makers for IM cubes with built-in container and separate container



## IM-65 NE - C with built-in container

Net dimensions (mm)	633 x 506 x 860 (legs + 90 - 125)
Ice Storage capacity up to (kg)	26
Crated dimensions (mm)	735 x 570 x 1012
Crated Volume (m <sup>3</sup> )	0,42
Refrigerant	R134a - F-gas CO <sub>2</sub> eq: 260 kg



Cylinder Cube Ø 37 x 45 mm

Model	Ice cube type	Condenser	Production up to kg (24h) air 10°C / water 10°C	Production up to kg (24h) air 21°C / water 15°C	Electrical specs V/Hz/Ph	Power rating (W)	Net weight / gross (kg)	ITEM
IM-65 NE-C "Cylinder"	Cylinder	Air	55 (1309 cubes)	50 (1190 cubes)	220-240/50/1	400	53/61	E1FD-D011

## IM-100 NE - C with built-in container

Net dimensions (mm)	704 x 506 x 1200 (legs + 90 - 130)
Ice Storage capacity up to (kg)	50
Crated dimensions (mm)	805 x 580 x 1375
Crated Volume (m <sup>3</sup> )	0,64
Refrigerant	R134a - F-gas CO <sub>2</sub> eq: 364 kg



Cylinder Cube Ø 37 x 45 mm

Model	Ice cube type	Condenser	Production up to kg (24h) air 10°C / water 10°C	Production up to kg (24h) air 21°C / water 15°C	Electrical specs V/Hz/Ph	Power rating (W)	Net weight / gross (kg)	ITEM
IM-100 NE-C "Cylinder"	Cylinder	Air	85 (2023 cubes)	81 (1928 cubes)	220-240/50/1	630	76/85	E1FE-D013

## IM-240 DNE - C / DNE-C / XNE - C with separate container

Net dimensions	1084 x 700 x 500
Corresponding Bins (+possible top kits)	B - 340 SA (1xTK IM D2) F 650 - 42 S F 650 - 44 S F 950 - 48 S F 1025 - 52 S
Crated dimensions (mm) IM-240 DNE Storage Bin B - 340 SA	1196 x 825 x 640 1328 x 928 x 1194
Crated Volume (m <sup>3</sup> ) IM-240 ANE Storage Bin B - 340 SA	0,63 1,5
Crated weight (kg) B - 340 SA	88
Refrigerant	R404A CO <sub>2</sub> eq: 500 kg



IM-240 DNE-C  
on B - 801 SA  
(sold separately)



Cylinder Cube Ø 37 x 45 mm

Model	Ice cube type	Condenser	Production up to kg (24h) air 10°C / water 10°C	Production up to kg (24h) air 21°C / water 15°C	Electrical specs V/Hz/Ph	Power rating (W)	Net weight / gross (kg)	ITEM
IM-240 DNE - C "Cylinder"	Cylinder	Air	240 (5714 cubes)	220 (5238 cubes)	220-240/50/1	1330	88/101	E1CK-D101
IM-240 DWNE - C "Cylinder"	Cylinder	Water	235 (5595 cubes)	200 (4761 cubes)	220-240/50/1	1330	88/101	E1CL-D101
IM-240 XNE - C "Cylinder"	Cylinder	Air	240 (5714 cubes)	220 (5238 cubes)	220-240/50/1	930	78/89	E1CK-D006
IM-240 XWNE - C "Cylinder"	Cylinder	Water	235 (5595 cubes)	220 (5238 cubes)	220-240/50/1	860	78/89	E1CL-D106

Models with stainless steel frame



IM-240 DNE-C - Basic model with top panel  
IM-240 XNE-C - Stackable model with conveyor kit  
IM-240 XNE-C - Stackable model with conveyor kit  
B-340 SA



# IM Range

Ice makers for IM Cubes with built-in container and separate ice container



## IM-21 CNE with built-in container

Net dimensions (mm)	398 x 451 x 695
Ice Storage capacity up to (kg)	11,5
Crated dimensions (mm)	505 x 575 x 862
Crated Volume (m <sup>3</sup> )	0,25
Refrigerant	R134a-F-gas  CO2 eq: 157 kg



Large Cube mm 28 x 28 x 32

Model	Ice cube type	Cooling	Production up to kg (24h) air 10°C / water 10°C	Production up to kg (24h) air 21°C / water 15°C	Supply power V/Hz/Ph	Consum. electric (W)	Net weight / gross (kg)	ITEM
IM-21 CNE	Large	Air	22	19	220-240/50/1	240	34/39	E1FA-D003
IM-21 CNE (NAV)	Large	Air	22	19	115V/60Hz/1	240	34/39	E1FA-D005

## IM-30 CNE with built-in container

Net dimensions (mm)	398 x 451 x 695 (legs + 90 -125)
Ice Storage capacity up to (kg)	11,5
Crated dimensions (mm)	505 x 575 x 862
Crated Volume (m <sup>3</sup> )	0,25
Refrigerant	R134a-F-gas  CO2 eq: 186 kg



Large Cube mm 28 x 28 x 32  
Small Cube mm 25 x 25 x 32

Model	Ice cube type	Condenser	Production up to kg (24h) air 10°C / water 10°C	Production up to kg (24h) air 21°C / water 15°C	Electrical specs V/Hz/Ph	Power rating (W)	Net weight / gross (kg)	ITEM
IM-30 CNE	Large	Air	28	24	220-240/50/1	270	34/39	E1FA
IM-30 CNE-25	Small	Air	24	20	220-240/50/1	270	34/39	E1FA-D001
IM-30 CWNE	Large	Water	32	30	220-240/50/1	190	35/41	E1FA-D002
IM-30 CWNE-25	Small	Water	25	23	220-240/50/1	190	35/41	E1FA-D006
IM-30 CNE (G60)	Large	Air	27	24	230/60/1	270	34/39	E1FA-D004
IM-30 CWNE (G60)	Large	Acqua	27	24	230/60/1	270	34/39	E1FA-D008

## IM-45 CNE with built-in container

Net dimensions (mm)	633 x 511 x 690 (legs + 90 -125)
Ice Storage capacity up to (kg)	15
Crated dimensions (mm)	735 x 570 x 864
Crated Volume (m <sup>3</sup> )	0,36
Refrigerant	R134a-F-gas  CO2 eq: 229 kg



Large Cube mm 28 x 28 x 32  
Small Cube mm 25 x 25 x 23

Model	Ice cube type	Condenser	Production up to kg (24h) air 10°C / water 10°C	Production up to kg (24h) air 21°C / water 15°C	Electrical specs V/Hz/Ph	Power rating (W)	Net weight / gross (kg)	ITEM
IM-45 CNE	Large	Air	44	40	220-240/50/1	320	48/56	E1FC
IM-45 CNE-25	Small	Air	39	35	220-240V/50/1	330	48/56	E1FC-D001
IM-45 CNE (G60)	Large	Air	44	40	230/60/1	320	48/56	E1FC-D002

## IM-45 NE with built-in container

Net dimensions (mm)	503 x 456 x 840 (legs + 90 -125)
Ice Storage capacity up to (kg)	18
Crated dimensions (mm)	635 x 520 x 1007
Crated Volume (m <sup>3</sup> )	0,33
Refrigerant	R134a-F-gas  CO2 eq: 229 kg



Large Cube mm 28 x 28 x 32  
Small Cube mm 25 x 25 x 23

Model	Ice cube type	Condenser	Production up to kg (24h) air 10°C / water 10°C	Production up to kg (24h) air 21°C / water 15°C	Electrical specs V/Hz/Ph	Power rating (W)	Net weight / gross (kg)	ITEM
IM-45 NE	Large	Air	44	40	220-240/50/1	330	46/52	E1FB
IM-45 WNE	Large	Water	47	40	220-240/50/1	295	47/55	E1FB-D002
IM-45 NE-25	Small	Air	36	32	220-240/50/1	330	46/52	E1FB-D001
IM-45 WNE-25	Small	Water	43	42	220-240/50/1	310	47/55	????
IM-45 NE (G60)	Small	Air	46	40	230/60/1	360	46/52	E1FB-D003
IM-45 WNE (G60)	Large	Water	50	45	230/60/1	310	47/55	E1FB-D005
IM-45 NE-25 (G60)	Small	Air	39	35	230/60/1	330	46/52	E1FB-D004
IM-45 WNE-25 (G60)	Small	Water	43	42	230/60/1	310	47/55	E1FB-D006



# IM Range

Ice makers for IM cubes with built-in container and separate container

## IM-65 NE with built-in container

Net dimensions (mm)	633 x 506 x 840 (legs + 90 -125)
Ice Storage capacity up to (kg)	26
Crated dimensions (mm)	735 x 570 x 1012
Crated Volume	0,42
Refrigerant	R134a-F-gas  CO2 eq: 286 kg



Large Cube mm 28 x 28 x 32  
Small Cube mm 25 x 25 x 23

Model	Ice cube type	Condenser	Production up to kg (24h) air 10°C / water 10°C	Production up to kg (24h) air 21°C / water 15°C	Electrical specs V/Hz/Ph	Power rating (W)	Net weight / gross (kg)	ITEM
IM-65 NE	Large	Air	63	56	220-240/50/1	400	53/61	E1FD
IM-65 WNE	Large	Water	63	55	220-240/50/1	370	54/64	E1FD-D002
IM-65 NE-25	Small	Air	56	52	220-240/50/1	400	53/61	E1FD-D001
IM-65 WNE-25	Small	Air	56	52	220-240/50/1	400	53/61	E1FD-D013
IM-65 NE (G60)	Large	Air	62	58	230/60/1	370	53/61	E1FD-D003
IM-65 WNE (G60)	Large	Water	65	58	230/60/1	310	54/64	E1FD-D005
IM-65 NE-25 (G60)	Small	Air	59	52	230/60/1	370	53/61	E1FD-D004
IM-65 WNE-25 (G60)	Small	Water	66	58	230/60/1	310	54/64	E1FD-D006

## IM-100 CNE with built-in container

Net dimensions (mm)	1004 x 600 x 800 (legs + 70-100)
Ice Storage capacity up to (kg)	38
Crated dimensions (mm)	1110 x 700 x 875
Crated Volume (m <sup>3</sup> )	0,68
Refrigerant	R134a-F-gas  CO2 eq: 400 kg



Large Cube mm 28 x 28 x 32  
Extra small Cube mm 21 x 21 x 14  
Medium Cube mm 28 x 28 x 23

Model	Ice cube type	Condenser	Production up to kg (24h) air 10°C / water 10°C	Production up to kg (24h) air 21°C / water 15°C	Electrical specs V/Hz/Ph	Power rating (W)	Net weight / gross (kg)	ITEM
IM-100 CNE	Large	Air	95	93	220-240/50/1	630	77/88	E1FE-D010
IM-100 CNE-21	Extra small	Air	92	87	220-240/50/1	630	77/88	E1FE-D012
IM-100 CNE-23	Medium	Air	79	77	220-240/50/1	630	77/88	E1FE-D011
IM-100 CNE (G60)	Large	Air	98	93	230/60/1	650	77/88	E1FE-D015

## IM-100 NE with built-in container

Net dimensions (mm)	704 x 506 x 1200 (legs + 70 - 100)
Ice Storage capacity up to (kg)	50
Crated dimensions (mm)	805 x 580 x 1375
Crated Volume (m <sup>3</sup> )	0,64
Refrigerant	R134a-F-gas  CO2 eq: 400 kg



Large Cube mm 28 x 28 x 32  
Medium Cube mm 28 x 28 x 23  
Cubetto Extra small Cube mm 21 x

Model	Ice cube type	Condenser	Production up to kg (24h) air 10°C / water 10°C	Production up to kg (24h) air 21°C / water 15°C	Electrical specs V/Hz/Ph	Power rating (W)	Net weight / gross (kg)	ITEM
IM-100 NE	Large	Air	95	95	220-240/50/1	630	76/85	E1FE
IM-100 WNE	Large	Water	97	95	220-240/50/1	540	74/84	E1FE-D002
IM-100 NE-23	Medium	Air	79	77	220-240/50/1	630	76/84	E1FE-D001
IM-100 WNE-23	Medium	Water	81	79	220-240/50/1	650	76/84	E1FE-D014
IM-100 NE-21	Extra small	Air	98	95	220-240/50/1	630	76/84	E1FE-D003
IM-100 WNE-21	Extra small	Water	96	88	220-240/50/1	540	74/84	E1FE-D007
IM-100 NE (G60)	Large	Air	98	93	230V/60Hz/1	650	76/84	E1FE-D004
IM-100 WNE (G60)	Large	Water	104	98	230V/60Hz/1	600	74/84	E1FE-D008
IM-100 NE-21 (G60)	Extra small	Air	98	95	230V/60Hz/1	650	76/84	E1FE-D005
IM-100 NE-23 (G60)	Medium	Air	81	79	230V/60Hz/1	650	76/84	E1FE-D006
IM-100 WNE-21 (G60)	Extra small	Water	103	97	230V/60Hz/1	600	74/84	E1FE-D009



# IM Range

Ice makers for IM cubes with built-in container and separate container

## IM-130 NE with built-in container

Net dimensions (mm)	704 x 506 x 1200 (legs+ 70 - 100)
Ice Storage capacity up to (kg)	50
Crated dimensions (mm)	805 x 580 x 1375
Crated Volume (m <sup>3</sup> )	0,64
Refrigerant	<b>R404A</b> CO <sub>2</sub> eq: 1490 kg



Large Cube mm 28 x 28 x 32  
Extra small Cube mm 21 x 21 x 14  
Medium Cube mm 28 x 28 x 23

Model	Ice cube type	Condenser	Production up to kg (24h) air 10°C / water 10°C	Production up to kg (24h) air 21°C / water 15°C	Electrical specs V/Hz/Ph	Power rating (W)	Net weight / gross (kg)	ITEM
IM-130 NE	Large	Air	120	112	220-240/50/1	700	76/85	E1FF
IM-130 WNE	Large	Water	127	112	220-240/50/1	640	74/84	E1FF-D002
IM-130 NE-23	Medium	Air	100	90	220-240/50/1	700	76/84	E1FF-D001
IM-130 WNE-23	Medium	Water	100	90	220-240/50/1	700	76/84	E1FF-D004
IM-130 NE-21	Extra small	Air	110	100	220-240/50/1	700	76/84	E1FF-D003

## IM-240 NE with built-in container

Net dimensions (mm)	704 x 665 x 1510 (legs + 70 - 110)
Ice Storage capacity up to (kg)	110
Crated dimensions (mm)	805 x 760 x 1684
Crated Volume (m <sup>3</sup> )	0,64
Refrigerant	<b>R404A</b> CO <sub>2</sub> eq: 1960 kg



Large Cube mm 28 x 28 x 32  
Extra small Cube mm 21 x 21 x 14  
Medium Cube mm 28 x 28 x 23

Model	Ice cube type	Condenser	Production up to kg (24h) air 10°C / water 10°C	Production up to kg (24h) air 21°C / water 15°C	Electrical specs V/Hz/Ph	Power rating (W)	Net weight / gross (kg)	ITEM
IM-240 NE	Large	Air	240	220	220-240/50/1	1320	111/128	E1EC
IM-240 WNE	Large	Water	240	225	220-240/50/1	1300	120/127	E1EC-D003
IM-240 NE-23	Medium	Air	225	215	220-240/50/1	1320	111/128	E1EC-D001
IM-240 WNE-23	Medium	Water	225	215	220-240/50/1	1320	111/128	E1EC-D004
IM-240 NE-21	Extra small	Air	217	210	220-240/50/1	1320	111/128	E1EC-D002

## IM-240 ANE with separate container

Net dimensions (mm)	560 x 700 x 880
Corresponding Bins (+possible top kits)	B - 140 SA B - 210 SA (TK 8 D) B - 340 SA (1xTK 8 D, 1xTK 18 D)
Crated dimensions (mm) IM-240 ANE Storage Bin B - 140 SA	665 x 820 x 1054 940 x 760 x 1190
Crated Volume (m <sup>3</sup> ) IM-240 ANE Storage Bin B - 140 SA	0,57 0,75
Crated weight (kg) B - 140 SA	49
Refrigerant	<b>R404A</b> CO <sub>2</sub> eq: 1882 kg



IM-240 ANE on B - 140 SA (sold separately)



IM-240 ANE on B-140 SA / B-210 SA / B-340 SA



Large Cube mm 28 x 28 x 32  
Extra small Cube mm 21 x 21 x 14  
Medium Cube mm 28 x 28 x 23

Model	Ice cube type	Condenser	Production up to kg (24h) air 10°C / water 10°C	Production up to kg (24h) air 21°C / water 15°C	Electrical specs V/Hz/Ph	Power rating (W)	Net weight / gross (kg)	ITEM
IM-240 ANE	Large	Air	240	220	220-240/50/1	1320	80/95	E1CP-D100
IM-240 ANE-23	Medium	Air	225	215	220-240/50/1	1320	80/95	E1CP-D101
IM-240 ANE-21	Extra small	Air	217	210	220-240/50/1	1320	80/95	E1CP-D102
IM-240 AWNE	Large	Water	240	225	220-240/50/1	1300	83/95	E1CP-D103
IM-240 AWNE-23	Medium	Water	220	200	220-240/50/1	1320	83/95	E1CP-D104
IM-240 AWNE-21	Extra small	Water	203	193	220-240/50/1	1320	80/95	E1CP-D105
IM-240 ANE (G60)	Large	Air	245	220	230/60/1	1320	80/95	E1CP-D109
IM-240 AWNE (G60)	Large	Water	240	220	230/60/1	1130	83/95	E1CP-D106
IM-240 AWNE-23 (G60)	Medium	Water	220	200	230/60/1	1130	83/95	E1CP-D107
IM-240 AWNE-21 (G60)	Extra small	Water	215	210	230/60/1	1130	83/95	E1CP-D108

All models with stainless steel frame





# IM Range

## Ice makers for IM cubes with separate container

### Basic model - 220-240/50/1 with condenser (with top panel)



Extra Large Cube mm 32 x 32 x 32  
 Large Cube mm 28 x 28 x 32  
 Medium Cube mm 25 x 25 x 23  
 Extra small Cube mm 21 x 21 x 14



IM-240 DNE on B - 340 SA  
 (sold separately)



IM-240 DNE - Basic model with top panel  
 IM-240 XNE - Stackable model without top panel and with ice funnel  
 IM-240 XNE - Stackable model without top panel and with ice funnel

B-340 SA

IM-240 DNE / IM 240 XNE with separate container	
Net dimensions (mm)	1084 x 700 x 500
Corresponding Bins (+possible top kits)	B-340 SA (1xTK IM D2) F 650 - 42 S F 650-44 S F 950 - 48 S F 1025 - 52 S
Crated dimensions (mm) IM-240 DNE Storage Bin B - 340 SA	1196 x 825 x 640 1328 x 928 x 1194
Crated Volume (m <sup>3</sup> ) IM-240 DNE Storage Bin B - 801 SA	0,63 1,5
Crated weight (kg) B - 340 SA	88
Refrigerant	R404A CO <sub>2</sub> eq: 1882 kg

Model	Ice cube type	Production up to kg (24h) air 10°C / water 10°C	Production up to kg (24h) air 21°C / water 15°C	Power rating (W)	Net weight / gross (kg)	ITEM
<b>Basic models 220-240/50/1 with remote condenser (with top panel)</b>						
IM-240 DSNE	Large	240	230	1330	85/97	E1CK-D124
IM-240 DSNE-23	Medium	225	215	1330	85/97	E1CK-D126
<b>Stackable models 220-240/50/1 with remote condenser (with conveyor kit)</b>						
IM-240 XSNE	Large	240	230	1330	81/95	E1CK-D125
IM-240 XSNE-23	Large	240	220	1330	88/101	E1CK-D127
<b>Remote condenser</b>						
URC-240 CE-4	Supply power	Consum. electric (W)		Net weight / gross (kg)	ITEM	
	220-240/50/1	1330		88/101	M021-D001	

### Basic models 220-240/50/1 air cooled (with top panel)

Model	Ice cube type	Production up to kg (24h) air 10°C / water 10°C	Production up to kg (24h) air 21°C / water 15°C	Power rating (W)	Net weight / gross (kg)	ITEM
IM-240 DNE-32	Extra large	220	210	1330	88/101	E1CK-D104
IM-240 DNE	Large	240	220	1330	88/101	E1CK-D100
IM-240 DNE-23	Medium	225	215	1330	88/101	E1CK-D102
IM-240 DNE-21	Extra small	217	210	1330	88/101	E1CK-D103

### Stackable models 220-240/50/1 air cooled (without top panel)

Model	Ice cube type	Production up to kg (24h) air 10°C / water 10°C	Production up to kg (24h) air 21°C / water 15°C	Power rating (W)	Net weight / gross (kg)	ITEM
IM-240 XNE-32	Extra large	220	210	1330	84/98	E1CK-D109
IM-240 XNE	Large	240	220	1330	84/98	E1CK-D105
IM-240 XNE-23	Medium	225	215	1330	84/98	E1CK-D107
IM-240 XNE-21	Extra small	217	210	1330	84/98	E1CK-D108

### Basic models 220-240/50/1 water cooled (with top panel)

Model	Ice cube type	Production up to kg (24h)	Production up to kg (24h)	Power rating (W)	Net weight / gross (kg)	ITEM
IM-240 DWNE-32	Large	240	220	1330	88/101	E1CL-D104
IM-240 DWNE	Large	240	220	1330	88/101	E1CL-D100
IM-240 DWNE-23	Medium	210	202	1300	87/100	E1CL-D102
IM-240 DWNE-21	Extra small	215	207	1300	87/100	E1CL-D103

### Stackable models 220-240/50/1 water cooled (without top panel)

Model	Ice cube type	Production up to kg (24h)	Production up to kg (24h)	Power rating (W)	Net weight / gross (kg)	ITEM
IM-240 XWNE-32	Extra large	215	195	1330	88/101	E1CL-D109
IM-240 XWNE	Large	240	220	1330	88/101	E1CL-D105
IM-240 XWNE-23	Medium	210	202	1300	83/98	E1CL-D107
IM-240 XWNE-21	Extra small	215	207	1300	83/98	E1CL-D108

### Basic models 230V/60Hz/1 air cooled (with top panel)

Model	Ice cube type	Production up to kg (24h)	Production up to kg (24h)	Power rating (W)	Net weight / gross (kg)	ITEM
IM-240 DNE (G60)	Large	245	220	1250	88/101	E1CK-D114
IM-240 DNE-23 (G60)	Medium	230	215	1250	88/101	E1CK-D116
IM-240 DNE-21 (G60)	Extra small	220	220	1250	88/101	E1CK-D118

### Stackable models 230V/60Hz/1 air cooled (without top panel)

Model	Ice cube type	Production up to kg (24h)	Production up to kg (24h)	Power rating (W)	Net weight / gross (kg)	ITEM
IM-240 XNE (G60)	Large	245	220	1250	84/98	E1CK-D115
IM-240 XNE-23 (G60)	Medium	230	215	1250	84/98	E1CK-D117
IM-240 XNE-21 (G60)	Extra small	220	220	1250	84/98	E1CK-D119

### Basic models 230V/60Hz/1 water cooled (with top panel)

Model	Ice cube type	Production up to kg (24h)	Production up to kg (24h)	Power rating (W)	Net weight / gross (kg)	ITEM
IM-240 DWNE (G60)	Large	240	220	1130	87/100	E1CL-D114
IM-240 DWNE-23 (G60)	Medium	220	200	1130	87/100	E1CL-D120
IM-240 DWNE-21 (G60)	Extra small	215	210	1130	87/100	E1CL-D116

### Stackable models 230V/60Hz/1 water cooled (without top panel)

Model	Ice cube type	Production up to kg (24h)	Production up to kg (24h)	Power rating (W)	Net weight / gross (kg)	ITEM
IM-240 XWNE (G60)	Large	240	220	1330	88/101	E1CL-D115
IM-240 XWNE-23 (G60)	Medium	220	200	1130	83/98	E1CL-D121
IM-240 XWNE-21 (G60)	Extra small	215	210	1130	83/98	E1CL-D117

\* Model with stainless steel frame



# IM Range Special Cube



Ice makers for IM cubes  
with built-in container



## IM-65 NE - Q / LM / LM Big Shot / LM103 with built-in container

Net dimensions (mm)	633 x 506 x 860 (legs+ 90 - 125)
Ice Storage capacity up to (kg)	17-model Q 26-model LM 26-model LM 103
Crated dimensions (mm)	735 x 570 x 1012
Crated Volume (m <sup>3</sup> )	0,33
Refrigerant	Model Q R134a-F-gas CO <sub>2</sub> eq: 260 kg



Ball Cube Ø 45 mm

Model	Ice cube type	Condenser	Production up to kg (24h) air 10°C / water 10°C	Production up to kg (24h) air 21°C / water 15°C	Electrical specs V/Hz/Ph	Power rating (W)	Net weight / gross (kg)	ITEM
IM-65 NE-Q "Ball"	Ball	Air	26 (577 cubes)	24 (533 cubes)	220-240/50/1	390	53/66	E1FD-D012
IM-65 WNE-Q "Ball"	Ball	Water	24 (533 cubes)	23 (511 cubes)	220-240/50/1	350	53/66	E1FD-D015



XXL Big Cube mm 48 x 58 x 48

Model	Ice cube type	Condenser	Production up to kg (24h) air 10°C / water 10°C	Production up to kg (24h) air 21°C / water 15°C	Electrical specs V/Hz/Ph	Power rating (W)	Net weight / gross (kg)	ITEM
IM-65 NE-LM "Big"	XXL Big	Air	40 (333 cubes)	33 (275 cubes)	220-240/50/1	400	53/61	E1FD-D009



XXXL Long Cube mm 58 x 103 x 48

Model	Ice cube type	Condenser	Production up to kg (24h) air 10°C / water 10°C	Production up to kg (24h) air 21°C / water 15°C	Electrical specs V/Hz/Ph	Power rating (W)	Net weight / gross (kg)	ITEM
IM-65NE-LM 103 "Long"	XXXL Long	Air	32 (133 cubes)	28 (116 cubes)	220-240/50/1	400	53/61	E1FD-D010

## IM-65 NE - H / S with built-in container

Net dimensions (mm)	633 x 506 x 860 (legs+ 90 - 125)
Ice Storage capacity up to (kg)	26
Crated dimensions (mm)	735 x 570 x 1012
Crated Volume (m <sup>3</sup> )	0,33
Refrigerant	Model Q R134a-F-gas CO <sub>2</sub> eq: 260 kg



Heart Cube mm 40 x 23 x 40

Model	Ice cube type	Condenser	Production up to kg (24h) air 10°C / water 10°C	Production up to kg (24h) air 21°C / water 15°C	Electrical specs V/Hz/Ph	Power rating (W)	Net weight / gross (kg)	ITEM
IM-65 NE-H "Heart"	Heart	Air	28 (1120 cubes)	27 (1080 cubes)	220-240/50/1	400	53/61	E1FD-D007



Star Cube mm 38 x 23 x 38

Model	Ice cube type	Condenser	Production up to kg (24h) air 10°C / water 10°C	Production up to kg (24h) air 21°C / water 15°C	Electrical specs V/Hz/Ph	Power rating (W)	Net weight / gross (kg)	ITEM
IM-65 NE-S "Star"	Star	Air	22 (1222 cubes)	21 (1166 cubes)	220-240/50/1	400	53/61	E1FD-D008



## FM Range

Ecological ice makers for Flake and Nugget ice with built-in and separate container

### Granular Ice (Flake)



### Granular Ice (Nugget and Cubelet ice)

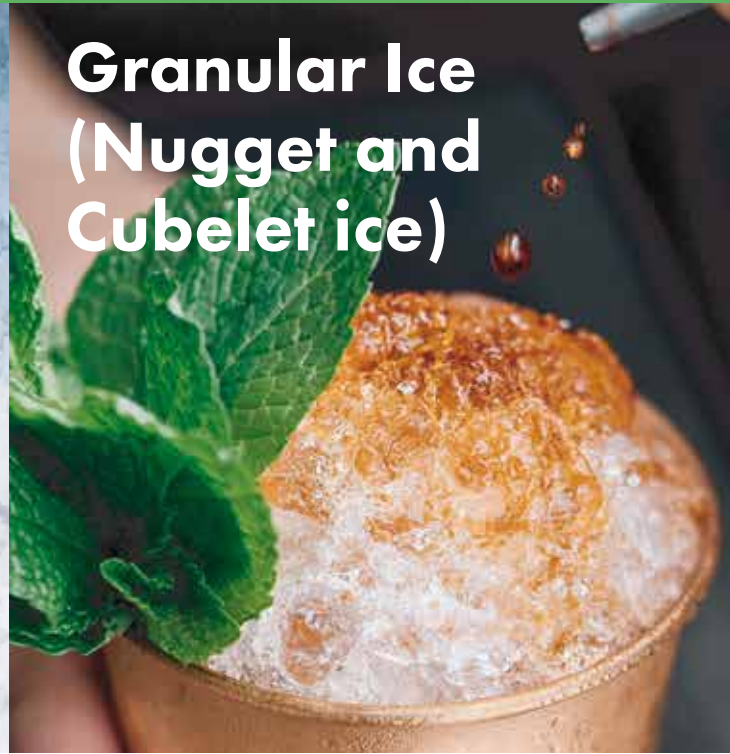

## FM Range features

Granular ice comes in Flake (soft and humid), Nugget (dry and hard, large size) and Cubelet (dry and hard, small size) variants. These are very versatile forms of ice, suitable for a wide variety of uses. The main characteristic of Hoshizaki's Granular ice is that it avoids the "weight loss" of fresh fish and meat, usually caused by dynamic or ventilated refrigeration, by maintaining the products at the correct storage temperature, well hydrated, preserving the organoleptic characteristics and finally their commercial value.

Hoshizaki ice makers in the Granular Ice range can be easily converted from Flake ice to Nugget ice production, contrary to all other granular ice makers on the market. Thanks to the "Auger System" used by Hoshizaki, the water introduced into the freezing cylinder is transformed 100% into ice, without waste.

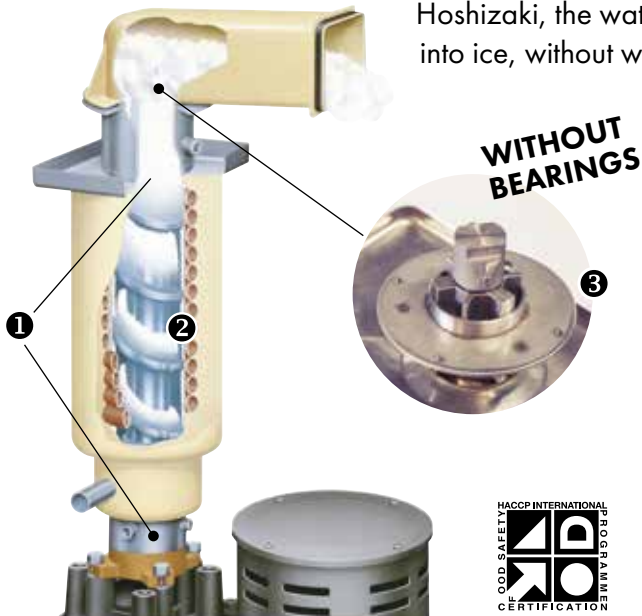

- 1 The auger rotation is assured by long-lasting, self-lubricating carbon fiber bushings, which are replaced effortlessly upon a given number of working hours, during ordinary maintenance.
- 2 Our tempered steel, endless-screw design, auger system is very robust, for added durability. It pushed the forming ice flakes through the extrusion head (which in turn compresses the ice granules to the desired level of hardness and humidity), ensuring longer machine life and reduced maintenance costs.
- 3 At the end of the ice freezing process, the cutter (a rotating set of blades), different according the desired result, size the granules of ice into Flake, Nugget or Cubelet.

TYPE OF ICE	ICE	RESIDUAL WATER
Flake ICE	70%	30%
Nugget	88%	12%
Cubelet	90%	10%





# FM Range

Ecological ice makers  
for Flake and Nugget ice  
with built-in and  
separate  
container



## FM-60 KE-HC / CM-50KE-HC with built-in container

Net dimensions (mm)	498 x 570 x 697 (legs 89 mm)
Ice Storage capacity up to (kg)	18 - Flake 18 - Cubelet
Crated dimensions (mm)	595 x 680 x 873
Crated Volume (m <sup>3</sup> )	0,35
Refrigerant	R290



Model	Ice type	Condenser	Production up to kg (24h) air 10°C / water 10°C	Production up to kg (24h) air 21°C / water 15°C	Electrical specs V/Hz/Ph	Power rating (W)	Net weight / gross (kg)	ITEM
FM-60 KE-HC	Flake	Air	65	60	220-240/50/1	270	49/58	F161
CM-50KE-HC	Cubelet	Air	55	50	220-240/50/1	270	49/58	F161-C103

## FM-80 KE-HC / FM-80 KE-HCN\* with built-in container

Net dimensions (mm)	640 x 600 x 800 (legs 89 mm)
Ice Storage capacity up to (kg)	26 - Flake 32 - Nugget
Crated dimensions (mm)	746 x 706 x 887
Crated Volume (m <sup>3</sup> )	0,47
Refrigerant	R290



Model	Ice type	Condenser	Production up to kg (24h) air 10°C / water 10°C	Production up to kg (24h) air 21°C / water 15°C	Electrical specs V/Hz/Ph	Power rating (W)	Net weight / gross (kg)	ITEM
FM-80 KE-HC	Flake	Air	85	75	220-240/50/1	270	65/75	F114
FM-80 KE-HCN	Nugget	Air	75	65	220-240/50/1	270	65/75	F114-C106

## FM-120 KE-HC / FM-120 KE-HCN\* with built-in container

Net dimensions (mm)	640 x 600 x 800 (legs 89 mm)
Ice Storage capacity up to (kg)	26 - Flake 32 - Nugget
Crated dimensions (mm)	746 x 706 x 887
Crated Volume (m <sup>3</sup> )	0,47
Refrigerant	R290



Model	Ice type	Condenser	Production up to kg (24h) air 10°C / water 10°C	Production up to kg (24h) air 21°C / water 15°C	Electrical specs V/Hz/Ph	Power rating (W)	Net weight / gross (kg)	ITEM
FM-120 KE-HC	Flake	Air	125	105	220-240/50/1	355	66/76	F115
FM-120 KE-HCN	Nugget	Air	110	96	220-240/50/1	355	66/76	F115-C106

## FM-120 KE-50-HC / FM 120-KE-50-HCN with built-in container

Net dimensions (mm)	940 x 600 x 800 (legs 89 mm)
Ice Storage capacity up to (kg)	57 - Flake 65 - Nugget
Crated dimensions (mm)	1046 x 706 x 887
Crated Volume (m <sup>3</sup> )	0,65
Refrigerant	R290



Model	Ice type	Condenser	Production up to kg (24h) air 10°C / water 10°C	Production up to kg (24h) air 21°C / water 15°C	Electrical specs V/Hz/Ph	Power rating (W)	Net weight / gross (kg)	ITEM
FM-120 KE-50-HC	Flake	Air	125	105	220-240/50/1	355	76/88	F115-C127
FM-120 KE-50-HCN	Nugget	Air	110	96	220-240/50/1	355	76/88	F115-C129

## FM-150 AKE-HC-SB FM 150 AKE-HCN-SB with separate container

Net dimensions (mm)	560 x 700 x 780
Corresponding Bins (+possible top kits)	B - 140 SA B - 210 SA B - 340 SA
Crated dimensions (mm) FM-150 AKE Storage Bin B - 301 SA	665 x 820 x 950 940 x 760 x 1190
Crated Volume (m <sup>3</sup> ) FM-150 AKE Storage Bin B - 140SA	0,51 0,75
Crated weight (kg) B - 140 SA	49
Refrigerant	R290



Model	Ice type	Condenser	Production up to kg (24h) air 10°C / water 10°C	Production up to kg (24h) air 21°C / water 15°C	Electrical specs V/Hz/Ph	Power rating (W)	Net weight / gross (kg)	ITEM
FM-150 AKE-HC-SB	Flake	Air	150	125	220-240/50/1	405	63/70	F128-C101
FM-150 AKE-HCN-SB	Nugget	Air	140	120	220-240/50/1	405	63/70	F128-C107



FM-300 AKE HC / HCN on B-140 SA / B-210 SA / B-340 SA

FM-150 AKE-HC-SB / HCN-SB  
+ B - 140 SA (sold separately)



# FM Range

Ecological ice makers  
for Flake and Nugget ice  
with separate  
container



## FM-300 AKE-HC-SB FM 300-AKE-HCN-SB with separate container

Net dimensions (mm)	560 x 700 x 780
Corresponding Bins (+possible top kits)	B-140 SA B-210 SA B-340 SA
Crated dimensions (mm) FM-300 AKE Storage Bin B - 140SA	655 x 820 x 950 667 x 928 x 1190
Crated Volume (m <sup>3</sup> ) FM-300 AKE Storage Bin B - 140SA	0,51 0,74
Crated weight (kg) B - 140 SA	53
Refrigerant	R290



**FM-300 AKE - HC  
+ B - 140 SA  
(sold separately)**

Model	Ice type	Condenser	Production up to kg (24h) air 10°C / water 10°C	Production up to kg (24h) air 21°C / water 15°C	Electrical specs V/Hz/Ph	Power rating (W)	Net weight / gross (kg)	ITEM
FM-300 AKE HC-SB	Flake	Air	300	250	220-240/50/1	900	81/88	F088-C101
FM-300 AKE HCN-SB	Nugget	Air	250	210	220-240/50/1	960	81/88	F088-C107



FM-300 AKE-HC-SB  
on B-140 SA / B-210 SA / B-340 SA

## FM-480 AKE-HC-SB FM 480-AKE-HCN-SB with separate container

Net dimensions (mm)	560 x 700 x 780
Corresponding Bins (+possible top kits)	B-140 SA B-210 SA B-340 SA
Crated dimensions (mm) FM-480 AKE Storage Bin B - 140SA	655 x 820 x 950 667 x 928 x 1190
Crated Volume (m <sup>3</sup> ) FM-480 AKE Storage Bin B - 140SA	0,51 0,74
Crated weight (kg) B - 140 SA	53
Refrigerant	R290



**FM-480 AKE-HC-SB  
+ B - 140 SA  
(sold separately)**

Model	Ice type	Condenser	Production up to kg (24h) air 10°C / water 10°C	Production up to kg (24h) air 21°C / water 15°C	Electrical specs V/Hz/Ph	Power rating (W)	Net weight / gross (kg)	ITEM
FM-480 AKE-HC-SB	Flake	Air	450	400	220-240/50/1	1100	92/99	F087-C101
FM-480 AKE-HCN-SB	Nugget	Air	380	330	220-240/50/1	1170	92/99	F087-C107

SB: lower base in stainless steel



FM-480 AKE-HC-SB  
on B-140 SA / B-210 SA / B-340 SA

## FM-480 AWKE-R452-SB / FM-480 AWKE-R452N-SB with separate container

Net dimensions (mm)	560 x 700 x 780
Corresponding Bins (+possible top kits)	B-140 SA B-210 SA B-340 SA
Crated dimensions (mm) FM-480 AKE Storage Bin B - 140SA	655 x 820 x 950 667 x 928 x 1190
Crated Volume (m <sup>3</sup> ) FM-480 AKE Storage Bin B - 140SA	0,51 0,745
Crated weight (kg) B-140 SA	53
Refrigerant	R452A CO <sub>2</sub> eq: 370 g



**FM-480 AWKE-R452-SB  
+ B - 140 SA**

Model	Ice type	Condenser	Production up to kg (24h) air 10°C / water 10°C	Production up to kg (24h) air 21°C / water 15°C	Electrical specs V/Hz/Ph	Power rating (W)	Net weight / gross (kg)	ITEM
FM-480 AWKE-R452-SB	Flake	Water	420	380	220-240/50/1	1385	95/102	F087-C107
FM-480 AWKE-R452-N-SB	Nugget	Water	380	350	220-240/50/1	1450	95/102	F082-C222



FM-480 AWKE-R452-SB on B-140 SA / B-210 SA / B-340



# FM Range

Ecological ice makers  
for Flake and Nugget ice  
with separate  
container



### FM-600 AKE-R452-SB / FM-600 AKE-R452N-SB with separate container

Net dimensions (mm)	560 x 700 x 780
Corresponding Bins (+possible top kits)	B-140 SA B-210 SA (1xTK8D) B-340 SA (1xTK 8 D, 1xTK 18D)
Crated dimensions (mm)	
FM-600 AKE-R452-SB	655 x 820 x 950
Storage Bin B-140 SA	667 x 928 x 1190
Volume m <sup>3</sup>	
FM-600 AKE-R452-SB	0,51
B-140 SA	0,74
Crated weight (kg)	
B-140 SA	53
Refrigerant	R452A CO <sub>2</sub> eq: 700g



**FM-600 AKE-R452-SB + B - 140 SA (sold separately)**

Model	Ice type	Condenser	Production up to kg (24h) air 10°C / water 10°C	Production up to kg (24h) air 21°C / water 15°C	Electrical specs V/Hz/Ph	Power rating (W)	Net weight / gross (kg)	ITEM
FM-600 AKE-R452-SB	Flake	Air	600	540	220-240/50/1	1900	107/114	F083-C201
FM-600 AKE-R452N-SB	Nugget	Water	530	460	220-240/50/1	1900	107/114	F083-C207
FM-600 AWKE-R452-SB	Flake	Air	570	530	220-240/50/1	1705	107/114	F083-C222
FM-600 AWKE-R452N-SB	Nugget	Water	490	460	220-240/50/1	1760	107/114	F083-C223

SB: lower base in stainless steel



FM-600 AKE-R452-SB sopra B-140 SA / B-210 SA / B-340 SA

### FM-750AKE-R452-SB / FM-750AKE-R452N-SB with separate container

Net dimensions (mm)	762 x 700 x 780
Corresponding Bins (+possible top kits)	B-210 SA B-340 SA (1xTK8D)
Crated dimensions (mm)	
FM-750 AKE-R452-SB	873 x 820 x 947
B-210 SA	871 x 928 x 1201
Volume m <sup>3</sup>	
FM-750 AKE-R452-SB	0,68
B-210 SA	0,98
Crated weight (kg)	
B 210 SA	67
Refrigerant	R452A/1150g



**FM-750 AKE-R452-SB + B - 210 SA (sold separately)**

Model	Ice type	Condenser	Production up to kg (24h) air 10°C / water 10°C	Production up to kg (24h) air 21°C / water 15°C	Electrical specs V/Hz/Ph	Power rating (W)	Net weight / gross (kg)	ITEM
FM-750AKE-R452-SB	Flake	Air	750	650	220-240/50/1	1880	133/143	F054-C201
FM-750AKE-R452N-SB	Nugget	Air	590	500	220-240/50/1	2010	133/143	F054-C207

SB: lower base in stainless steel



FM-750 AKE-R452-SB on B-210 SA / B-340 SA

### FM-1000 AKE-R452-SB / FM-1000 AKE-R452N-SB with separate container

Net dimensions (mm)	762 x 700 x 780
Corresponding Bins (+possible top kits)	B-501 SA B-801 SA (1xTK-18D)
Crated dimensions (mm)	
FM-1000 AKE-R452-SB	873 x 820 x 947
B-501 SA	871 x 928 x 1201
Volume m <sup>3</sup>	
FM-1000 AKE-R452-SB	0,68
B-210 SA	0,98
Crated weight (kg)	
B-210 SA	67
Refrigerant	R452A/1350g



**FM-1000 AKE-R452 + B - 210 SA (sold separately)**

Model	Ice type	Condenser	Production up to kg (24h) air 10°C / water 10°C	Production up to kg (24h) air 21°C / water 15°C	Electrical specs V/Hz/Ph	Power rating (W)	Net weight / gross (kg)	ITEM
FM-1000AKE-R452-SB	Flake	Air	1030	890	220-240/50/1	2490	146/156	F055-C201
FM-1000AKE-R452N-SB	Nugget	Air	860	730	220-240/50/1	2550	146/156	F055-C207

SB: lower base in stainless steel



FM-1000 AKE-R452 on B-210 SA / B-340 SA



# FM Range

## Ecological ice makers for Flake and Nugget ice with separate container



### FM-1200 ALKE-R452-SB / FM-1200 ALKE-R452N-SBN with separate container

<b>Net dimensions (mm)</b>	762 x 700 x 780
<b>Corresponding Bins (+possible top kits)</b>	B-210 SA B-340 SA (1xTK-18D)
<b>Crated dimensions (mm)</b> FM-1200ALKE-R452-SB B-210 SA	873 x 820 x 947 871 x 928 x 1201
<b>Volume m<sup>3</sup></b> FM-1200ALKE-R452-SB B-210 SA	0,68 0,98
<b>Crated weight (kg)</b> B-210 SA	67
<b>Refrigerant</b>	R452A



FM-1200 ALKE-R452-SB  
+ B - 210 SA (sold separately)

Model	Ice type	Condenser	Production up to kg (24h) air 10°C / water 10°C	Production up to kg (24h) air 21°C / water 15°C	Electrical specs V/Hz/Ph	Power rating (W)	Net weight / gross (kg)	ITEM
FM-1200 ALKE-R452-SB	Flake	Air	1200	1040	220-240/50/1	470	98/108	F073-C201
FM-1200 ALKE-R452N-SB	Nugget	Air	1060	920	220-240/50/1	515	98/108	F073-C207

Units need a remote condenser (sold separately)



FM-1200 ALKE-R452-SB on B-210 SA / B-340 SA

### FM-1800 ALKE-R452-SB / FM-1800 ALKE-R452N-SB with separate container

<b>Net dimensions (mm)</b>	1080 x 700 x 780
<b>Corresponding Bins (+possible top kits)</b>	B-340 SA (1xTK1800)
<b>Crated dimensions (mm)</b> FM-1800 ALKE B-340 SA	1191 x 820 x 947 1328 x 928 x 1194
<b>Volume m<sup>3</sup></b> FM-1800 ALKE B-340 SA	0,92 1,5
<b>Crated weight (kg)</b> B 801 SA	88
<b>Refrigerant</b>	R452A



FM-1800 ALKE-R452-SB  
+ B - 340 SA (sold separately)

Model	Ice type	Condenser	Production up to kg (24h) air 10°C / water 10°C	Production up to kg (24h) air 21°C / water 15°C	Electrical specs V/Hz/Ph	Power rating (W)	Net weight / gross (kg)	ITEM
FM-1800 ALKE-R452-SB	Flake	Air	1800	1560	220-240/50/1	710	140/155	F074-C201
FM-1800 ALKE-R452N-SB	Nugget	Air	1590	1380	220-240/50/1	770	140/155	F074-C207

Units need a remote condenser (sold separately)

### URC-240C-E-4 Remote Condenser

<b>Net dimensions (mm)</b>	657 x 399 x 476
<b>Crated dimensions (mm)</b>	768 x 468 x 561
<b>Volume m<sup>3</sup></b>	0,20
<b>Refrigerant</b>	R404A/1000g



Model	Condenser	Electrical specs V/Hz/Ph	Power rating (W)	Net weight / gross (kg)	ITEM
URC-240C-E-4	Air	220-240/50/1	-	20/25	M021-D001



# FM Range

## Ice makers for Flake and Nugget ice with built-in container and separate container



**FM-80 KE / FM-80 KE-N with built-in container**

Net dimensions (mm)	640 x 600 x 800 (legs 89 mm)
Ice Storage capacity up to (kg)	26 - Flake 32 - Nugget
Crated dimensions (mm)	746 x 706 x 887
Crated Volume (m <sup>3</sup> )	0,47
Refrigerant	R134a - F-gas  CO <sub>2</sub> eq: 215 kg



Model	Ice type	Condenser	Production up to kg (24h) air 10°C / water 10°C	Production up to kg (24h) air 21°C / water 15°C	Electrical specs V/Hz/Ph	Power rating (W)	Net weight / gross (kg)	ITEM
FM-80 KE	Flake	Air	85	75	220-240/50/1	300	65/75	F079
FM-80 KE-N	Nugget	Air	65	55	220-240/50/1	300	65/75	F079-C106

**FM-120 KE with built-in container**

Net dimensions (mm)	640 x 600 x 800 (legs 89 mm)
Ice Storage capacity up to (kg)	26 - Flake
Crated dimensions (mm)	746 x 706 x 887
Crated Volume (m <sup>3</sup> )	0,47
Refrigerant	R134a - F-gas  CO <sub>2</sub> eq: 315 kg



Model	Ice type	Condenser	Production up to kg (24h) air 10°C / water 10°C	Production up to kg (24h) air 21°C / water 15°C	Electrical specs V/Hz/Ph	Power rating (W)	Net weight / gross (kg)	ITEM
FM-120 KE (G60)	Flake	Air	145	120	230/60/1	TBA	TBA	F080-C131

**FM-150 KE / FM-150 KE-N CM-140 KE with built-in container**

Net dimensions (mm)	640 x 600 x 800 (legs 89 mm)
Ice Storage capacity up to (kg)	26 - Flake 32 - Nugget 32 - Cubelet
Crated dimensions (mm)	746 x 706 x 887
Crated Volume (m <sup>3</sup> )	0,47
Refrigerant	R134a - F-gas  CO <sub>2</sub> eq: 315 kg



Model	Ice type	Condenser	Production up to kg (24h) air 10°C / water 10°C	Production up to kg (24h) air 21°C / water 15°C	Electrical specs V/Hz/Ph	Power rating (W)	Net weight / gross (kg)	ITEM
FM-150 KE	Flake	Air	150	130	220-240/50/1	640	71/82	F080
FM-150 KE-N	Nugget	Air	140	120	220-240/50/1	640	71/82	F080-C106
CM-140 KE	Cubelet	Air	140	115	220-240/50/1	640	71/82	F080-C103

**FM-150 KE-50 / FM-150 KE-50-N with built-in container**

Net dimensions (mm)	940 x 600 x 800 (legs 89 mm)
Ice Storage capacity up to (kg)	57 - Flake 65 - Nugget
Crated dimensions (mm)	1046 x 706 x 887
Crated Volume (m <sup>3</sup> )	0,65
Refrigerant	R134a - F-gas  CO <sub>2</sub> eq: 315 kg



Model	Ice type	Condenser	Production up to kg (24h) air 10°C / water 10°C	Production up to kg (24h) air 21°C / water 15°C	Electrical specs V/Hz/Ph	Power rating (W)	Net weight / gross (kg)	ITEM
FM-150 KE-50	Flake	Air	150	130	220-240/50/1	640	81/94	F080-C127
FM-150 KE-50-N	Nugget	Air	140	120	220-240/50/1	640	81/94	F080-C129





# FM Range

## Ice makers for Flake and Nugget ice with separate container



### FM-300 AKE-SB / FM-300 AKE-N-SB with separate container

Net dimensions (mm)	560 x 700 x 780
Corresponding Bins (+possible top kits)	B-140 SA B-210 SA (1xTK 8 D) B-340 SA (1xTK 8 D, 1xTK18D)
Crated dimensions (mm) FM-300 AKE Storage Bin B-140 SA	655 x 820 x 950 667 x 928 x 1190
Crated Volume (m <sup>3</sup> )	
FM-300 AKE	0,51
Storage Bin B-140 SA	0,74
Crated weight (kg) B - 140 SA	53
Refrigerant	R404A CO <sub>2</sub> eq: 1803 kg



FM-300 AKE + B - 140 SA (sold separately)

Model	Ice type	Condenser	Production up to kg (24h) air 10°C / water 10°C	Production up to kg (24h) air 21°C / water 15°C	Electrical specs V/Hz/Ph	Power rating (W)	Net weight / gross (kg)	ITEM
FM-300 AKE-SB	Flake	Air	320	260	220-240/50/1	1000	80/87	F081-C101
FM-300 AKE-N-SB	Nugget	Air	270	225	220-240/50H/1	1000	80/87	F081-C107
FM-300 AKE (G60)	Flake	Air	270	200	230/60/1	1180	80/87	F081-C130
FM-300 AKE-N (G60)	Nugget	Air	240	180	220-240/50H/1	1200	80/87	F081-C131

SB = Lower plate in stainless steel



FM-300 AKE on B-140 SA / B-210 SA / B-340 SA

### FM-480 AKE-SB / FM-480 AKE-N-SB with separate container

Net dimensions (mm)	560 x 700 x 780
Corresponding Bins (+possible top kits)	B-140 SA B-210 SA (1xTK8D) B-340 SA (1xTK 8 D, 1xTK18D)
Crated dimensions (mm) FM-480 AKE Storage Bin B-301 SA	655 x 820 x 950 667 x 928 x 1190
Crated Volume (m <sup>3</sup> )	
FM-480 AKE	0,51
Storage Bin B-140 SA	0,74
Crated weight (kg) B - 140 SA	53
Refrigerant	R404A CO <sub>2</sub> eq: 2352 kg



FM-480 AKE-SB + B - 140 SA (sold separately)

Model	Ice type	Condenser	Production up to kg (24h) air 10°C / water 10°C	Production up to kg (24h) air 21°C / water 15°C	Electrical specs V/Hz/Ph	Power rating (W)	Net weight / gross (kg)	ITEM
FM-480 AKE-SB	Flake	Air	500	425	220-240/50/1	1650	95/102	F082-C101
FM-480 AKE-N-SB	Nugget	Air	430	360	220-240/50/1	1650	95/102	F082-C107
FM-480 AWKE-SB	Flake	Water	420	380	220-240/50/1	1385	95/102	F082-C122
FM-480 AWKE-N-SB	Nugget	Water	380	350	220-240/50/1	1450	95/102	F082-C123
FM-480 AKE (G60)	Flake	Air	430	330	230/60/1	IVD	TBA	F082-C130
FM-480 AKE-N (G60)	Nugget	Air	370	280	230/60/1	1590	95/102	F082-C131

SB = Lower plate in stainless steel



FM-480 AKE-SB on B-140 SA / B-210 SA / B-340 SA



# FM Range

## Ice makers for Flake and Nugget ice with separate container



### FM-600 AKE / FM-600 AKE-N-SB with separate container

Net dimensions (mm)	560 x 700 x 780
Corresponding Bins (+possible top kits)	B-140 SA B-210 SA (1xTK8D) B-340 SA (1xTK 8 D, 1xTK18D)
Crated dimensions (mm)	
FM-600 AKE	655 x 820 x 950
Storage Bin B-140 SA	667 x 928 x 1201
Crated Volume (m <sup>3</sup> )	
FM-600 AKE	0,51
Storage Bin B-140 SA	0,75
Crated weight (kg)	
B-140 SA	53
Refrigerant	<b>R404A</b> <b>CO<sub>2</sub> eq: 5096 kg</b>



FM-600 AKE  
+ B - 140 SA  
(sold separately)

Model	Ice type	Condenser	Production up to kg (24h) air 10°C / water 10°C	Production up to kg (24h) air 21°C / water 15°C	Electrical specs V/Hz/Ph	Power rating (W)	Net weight / gross (kg)	ITEM
FM-600 AKE-SB	Flake	Air	600	540	220-240/50/1	1900	107/114	F083-C101
FM-600 AKE-N-SB	Nugget	Air	530	460	220-240/50/1	1950	107/114	F083-C107
FM-600 AWKE-SB	Flake	Water	600	560	220-240/50/1	1705	107/114	F083-C122
FM-600 AWKE-N-SB	Nugget	Water	490	460	220-230/60/1	1760	107/114	F083-C123
FM-600 AKE (G60)	Flake	Air	540	445	230/60/1	1900	107/114	F083-C130
FM-600 AKE-N-SB (G60)	Nugget	Air	460	400	230V/60/1	1950	107/114	F083-C131

SB = Lower plate in stainless steel



FM-600 AKE on B-140 SA / B-210 SA / B-340 SA

### FM-750 AKE / FM-750 AKE-N-SB with separate container

Net dimensions (mm)	762 x 700 x 780
Corresponding Bins (+possible top kits)	B-210 SA B-340 SA (1xTK8D)
Crated dimensions (mm)	
FM-750 AKE	873 x 820 x 947
Storage Bin B-210 SA	871 x 928 x 1201
Crated Volume (m <sup>3</sup> )	
FM-750 AKE	0,68
Storage Bin B-210 SA	0,98
Crated weight (kg)	
B-210 SA	67
Refrigerant	<b>R404A</b> <b>CO<sub>2</sub> eq: 4508 kg</b>



FM-750 AKE  
+ B - 210 SA (sold separately)

Model	Ice type	Condenser	Production up to kg (24h) air 10°C / water 10°C	Production up to kg (24h) air 21°C / water 15°C	Electrical specs V/Hz/Ph	Power rating (W)	Net weight / gross (kg)	ITEM
FM-750 AKE-SB	Flake	Air	750	650	220-24/50/1	1880	133/143	F054-C101
FM-750 AKE-N-SB	Nugget	Air	590	500	220-240/50/1	2010	133/143	F054-C107

SB = Lower plate in stainless steel



FM-750 AKE on B-210 SA / B-340 SA

### FM-1000 AKE / FM-1000 AKE-N-SB with separate container

Net dimensions (mm)	762 x 700 x 780
Corresponding Bins (+possible top kits)	B-210 SA B-340 SA (1xTK-18D)
Crated dimensions (mm)	
FM-1000 AKE	873 x 820 x 947
Storage Bin B-210 SA	871 x 928 x 1201
Crated Volume (m <sup>3</sup> )	
FM-1000 AKE	0,68
Storage Bin B-210 SA	0,98
Crated weight (kg)	
B-210 SA	67
Refrigerant	<b>R404A</b> <b>CO<sub>2</sub> eq: 5292 kg</b>



FM-1000 AKE  
+ B - 210 SA  
(sold separately)

Model	Ice type	Condenser	Production up to kg (24h) air 10°C / water 10°C	Production up to kg (24h) air 21°C / water 15°C	Electrical specs V/Hz/Ph	Power rating (W)	Net weight / gross (kg)	ITEM
FM-1000 AKE-SB	Flake	Air	1030	890	220-240/50/1	2490	146/156	F055-C101
FM-1000 AKE-N-SB	Nugget	Air	860	730	220-240/50/1	2550	146/156	F055-C107

SB = Lower plate in stainless steel

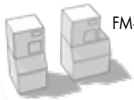

FM-1000 AKE on B-210 SA / B-340 SA



# FM Range

## Ice makers for Flake and Nugget ice with separate container



FM-1200 ALKE / FM-1200 ALKE-N-SB - with separate container	
Net dimensions (mm)	762 x 700 x 780
Corresponding Bins (+possible top kits)	B-210 SA B-340 SA (1xTK 18D)
Crated dimensions (mm)	
FM-1200 ALKE	873 x 820 x 947
Storage Bin B-210 SA	871 x 928 x 1201
Crated Volume (m <sup>3</sup> )	
FM-1200 ALKE	0,68
Storage Bin B-210 SA	0,98
Crated weight (kg)	
B-210 SA	67
Refrigerant	<b>R404A</b> <b>CO2 eq: 118 kg</b>



**FM-1200 ALKE + B - 210 SA**  
(sold separately)

Model	Ice type	Condenser	Production up to kg (24h) air 10°C / water 10°C	Production up to kg (24h) air 21°C / water 15°C	Electrical specs V/Hz/Ph	Power rating (W)	Net weight / gross (kg)	ITEM
FM-1200 ALKE-SB	Flake	Air	1200	1040	220-240/50/1	470	98/108	F073-C101
FM-1200 ALKE-N-SB	Nugget	Air	1060	920	220-240/50/1	515	98/108	F073-C107

Requires Remote Refrigeration Unit (not supplied)



FM-1200 ALKE on B-210 SA / B-340 SA

FM-1800 ALKE / FM-1800 ALKE-N-SB- with separate container	
Dimensions (mm)	1080 x 700 x 780
Corresponding Bins (+possible top kits)	B-340 SA (1xTK1800)
Size with packaging (mm)	
FM-1800 ALKE	1191 x 820 x 947
Storage Bin B - 340 SA	1328 x 928 x 1194
Volume (m <sup>3</sup> )	
FM-1800 ALKE	0,92
Storage Bin B - 340 SA	1,5
Crated weight (kg)	
B - 340 SA	88
Refrigerant	<b>R404A</b> <b>CO2 eq: 118 kg</b>



**FM-1800 ALKE + B - 340 SA**  
(sold separately)

Model	Ice type	Condenser	Production up to kg (24h) air 10°C / water 10°C	Production up to kg (24h) air 21°C / water 15°C	Electrical specs V/Hz/Ph	Power rating (W)	Net weight / gross (kg)	ITEM
FM-1800 ALKE-SB	Flake	Air	1800	1560	220-240/50/1	710	140/155	F074-C101
FM-1800 ALKE-N-SB	Nugget	Air	1590	1380	220-240/50/1	770	140/155	F074-C107

Requires Remote Refrigeration Unit (not supplied)

# Crescent Ice: exclusive form of ice for record-breaking performance!

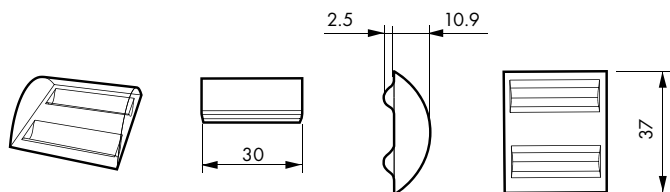

Hoshizaki's Crescent cube is crystal clear, shiny, rock-hard due to its high density, with a reduced heat exchanging surface area as it has no inner cavity. Formed and collected individually, it beats any competing ice forms in terms of slow-melting rate. It distributes evenly in the ice storage bin, resulting in a greater reserve of available ice. Last but not least, it also has one of the highest liquid displacement factors (replaces a high percentage of liquid within the glass): in other words, it is highly profitable!



EverCheck™ Control Board with audible alarm and diagnostic features, designed to assist service technicians in diagnosing problems. The majority of all service and maintenance can be accomplished from the front of unit. These controls are also located in a dry environment, greatly improving electrical component reliability.

Benefits:

- Consistent ice formation under all ambient conditions.
- Protection from water loss, or filter restriction.
- Eliminates mechanical moving parts: less down time, fewer repairs, longer life.



Hoshizaki's CycleSaver® technology allows Hoshizaki's KM machines to produce a given amount of ice in about half the production cycles when compared to same capacity competition ice makers.



An air filtration system, keeping the condenser clean, guarantees the maximum ice production, prolongs the life span of the machine and at the same time reduces the electrical consumption. The removable air filter allows users to

take care of this easy maintenance operation. The need for intervention by external technicians is minimized, as well as the total cost of life of the equipment.

The Crescent cube by Hoshizaki is the industry news when it comes to versatile ice. Its characteristics of total transparency, high density, rounded shape with reduced heat exchange surface, make it an ideal solution for a wide variety of applications.

**The Crescent ice is formed by Hoshizaki's patented KM evaporator, now in its improved, more efficient "Edge" configuration.**

This is the only evaporator in the world manufactured in stainless steel; its design favors a high speed transit of water across its surface, with a minimal contact time, preventing minerals from freezing alongside with water molecules during the freezing cycle. Virtually indestructible, this stainless-steel evaporator is unaffected by the use of corroding acids used in periodic descaling. The new configuration (Edge) considerably improves its thermal efficiency, thanks to the greater contact surface between the evaporator double-sided ice forming surface and the copper refrigerant tubing that are soldered right in between them.

**Two-sided production surface (Double).**

During refilling phase, at the end of each freezing cycle, water is channeled between the two evaporator surfaces, by then at sub-freezing temperatures; due to its warm temperature, incoming water automatically jump-starts the harvest cycle, reducing the need for the reversal of the compressor cycle, the standard way to detach ice cubes from the evaporator surfaces, thus generating great energy savings.

Furthermore, warm incoming and ice-harvesting water, having been pre-cooled by the contact with the cold evaporator surfaces, is preserved and used for the next ice-freezing cycle. The machine production cycle gets a free boost, having to use no energy in the process. **A true double benefit!**

The KM evaporator is mounted laterally, allowing easy access to the machine technical area for maintenance operations.

Hoshizaki's Crescent cube is crystal clear, shiny, rock-hard due to its high density, with a reduced heat exchanging surface area as it has no inner cavity. Formed and collected individually, it beats any competing ice forms in terms of slow-melting rate.

It distributes evenly in the ice storage bin, resulting in a greater reserve of available ice.

Last but not least, it also has one of the highest liquid displacement factors (replaces a high percentage of liquid within the glass): in other words, **it is highly profitable!**

Crescent ice is unsurpassed when used to chill bottles in wine buckets, where it is used without the need to add water. It is the ideal ice for high volume restaurants where quality and speed of service are sought for to make a real difference in the Customer experience.





# KM Range

Ecological ice makers  
for Crescent cube  
ice with built-in  
container and  
separate container



NATURAL  
REFRIGERANTS



## KM - 40C-HC / KM-40CHC-W with built-in container

Net dimensions (mm)	452 x 610 x 988 (with Legs 982-1005)
Ice Storage capacity up to (kg)	16
Crated dimensions (mm)	555x715 x 996
Crated Volume (m <sup>3</sup> )	0,40
Refrigerant	R290 / 68g



Model	Ice cube type	Condenser	Production up to kg (24h) air 10°C / water 10°C	Production up to kg (24h) air 21°C / water 15°C	Electrical specs V/Hz/Ph	Power rating (W)	Net weight / gross (kg)	ITEM
KM-40C-HC	Crescent	Air	43	41	220-240/50/1	220	39 / 49	F158-C141
KM-40C-HC-W	Crescent	Air	43	41	220-240/50/1	220	39 / 49	F158-C241

## KM - 60C-HC / KM-60C-HC-W with built-in container

Net dimensions (mm)	605 x 610 x 988 (with Legs 982-1005)
Ice Storage capacity up to (kg)	23
Crated dimensions (mm)	710x715 x 996
Crated Volume (m <sup>3</sup> )	0,51
Refrigerant	R290 / 68g



Model	Ice cube type	Condenser	Production up to kg (24h) air 10°C / water 10°C	Production up to kg (24h) air 21°C / water 15°C	Electrical specs V/Hz/Ph	Power rating (W)	Net weight / gross (kg)	ITEM
KM-60C-HC	Crescent	Air	60	52	220-240/50/1	255	45 / 57	F159-C141
KM-60C-HC-W	Crescent	Air	60	52	220-240/50/1	255	45 / 57	F159-C241

## KM - 80C-HC / KM-80C-HC-W with built-in container

Net dimensions (mm)	605 x 712 x 988 (with Legs 982-1005)
Ice Storage capacity up to (kg)	34
Crated dimensions (mm)	700x 805 x 996
Crated Volume (m <sup>3</sup> )	0,56
Refrigerant	R290 / 147g



Model	Ice cube type	Condenser	Production up to kg (24h) air 10°C / water 10°C	Production up to kg (24h) air 21°C / water 15°C	Electrical specs V/Hz/Ph	Power rating (W)	Net weight / gross (kg)	ITEM
KM-80C-HC	Crescent	Air	75	68	220-240/50/1	314	52 / 65	F160-C141
KM-80C-HC-W	Crescent	Air	75	68	220-240/50/1	314	52 / 65	F160-C241

## KM - 140C-HC / KM-140C-HC-W with built-in container

Net dimensions (mm)	630 x 719 x 1333 (with Legs 1335-1356)
Ice Storage capacity up to (kg)	55
Crated dimensions (mm)	700x 805 x 996
Crated Volume (m <sup>3</sup> )	0,81
Refrigerant	R290/110g



Model	Ice cube type	Condenser	Production up to kg (24h) air 10°C / water 10°C	Production up to kg (24h) air 21°C / water 15°C	Electrical specs V/Hz/Ph	Power rating (W)	Net weight / gross (kg)	ITEM
KM-140C-HC	Crescent	Air	138	130	220-240/50/1	564	69 / 81	F178-C141
KM-140C-HC-W	Crescent	Air	138	130	220-240/50/1	564	69 / 81	F178-C241

## KMD-210 ABE - HC with separate container

Net dimensions (mm)	560 x 625 x 610
Corresponding Bins (+possible top kits)	B-140 SA - B-210 SA (1xTK 8 D) - B-340 SA (1xTK 8D, 1xTK 18D) Dispenser Lancer
Crated dimensions (mm) - KMD-201 AA	668 x 727 x 793
Crated dimensions (mm) - B-140 SA	667 x 928 x 1190
Crated Volume m <sup>3</sup> KMD-201 AA	0,39
Crated Volume m <sup>3</sup> B-140 SA	0,74
Crated weight (kg) B 140 SA	53
Refrigerant	R290



Model	Ice cube type	Condenser	Production up to kg (24h) air 10°C / water 10°C	Production up to kg (24h) air 21°C / water 15°C	Electrical specs V/Hz/Ph	Power rating (W)	Net weight / gross (kg)	ITEM
KMD-210 ABE -HC	Crescent	Air	210	190	220-240/50/1	683	57/73	M099

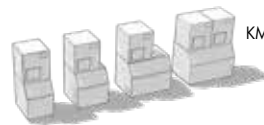

KMD-210 ABE-HC on B-140 SA / B-210 SA / B-340 SA

**KMD-210 AB - HC  
+ B - 140 SA  
(sold separately)**



# KM Range

## Ecological ice makers for Crescent cube ice with separate container



NATURAL  
REFRIGERANTS



### KMD-270 ABE - R452 with separate container

Net dimensions (mm)	560 x 625 x 610
Corresponding Bins (+possible top kits)	B-140 SA B-210 SA (1xTK 8 D) B-340 SA (1xTK 8D+TK18D, 1xTK 4DM+TK4DE)
Crated dimensions (mm)	
KMD-270 ABE	668 x 727 x 793
B-140 SA	667 x 928 x 1190
Crated Volume m <sup>3</sup>	
KMD-270 ABE-R452	0,37
B-140 SA	0,74
Crated weight (kg)	
B 140 SA	53
Refrigerant	R452/780g



**KMD-270 ABE - R452  
+ B - 140 SA  
(sold separately)**

Model	Ice cube type	Condenser	Production up to kg (24h) air 10°C / water 10°C	Production up to kg (24h) air 21°C / water 15°C	Electrical specs V/Hz/Ph	Power rating (W)	Net weight / gross (kg)	ITEM
KMD-270 ABE - R452	Crescent	Air	275	255	220-240/50/1	984	57/66	M098

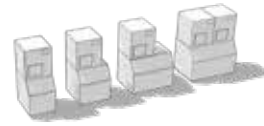

KMD-270 ABE-R452 on B-140 SA / B-210 SA / B-340 SA

### KMD-470AJE - R452 with separate container

Net dimensions (mm)	762 x 695 x 825
Corresponding Bins (+possible top kits)	B-210 SA (1xTK 30) B-340 SA (1xTK 30+TK 18D)
Crated dimensions (mm)	
KMD-270 ABE	794 x 867 x 1012
B-210 SA	873 x 928 x 1201
Crated Volume m <sup>3</sup>	
KMD-270 ABE-R452	0,70
B-210 SA	0,98
Crated weight (kg)	
B 210 SA	67
Refrigerant	R452/780g



Model	Ice cube type	Condenser	Production up to kg (24h) air 10°C / water 10°C	Production up to kg (24h) air 21°C / water 15°C	Electrical specs V/Hz/Ph	Power rating (W)	Net weight / gross (kg)	ITEM
KMD-470AJE - R452	Crescent	Air	495	480	220-240/50/1	1850	122/133	M097

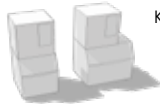

KMD-270 ABE-R452 on B-210 SA / B-340 SA

### KMD-590DJE - R452 with separate container

Net dimensions (mm)	1225 x 695 x 695
Corresponding Bins (+possible top kits)	B-340 SA (1xTK-48)
Crated dimensions (mm)	
KM-590DJE- R452	1324 x 796 x 880
B-340 SA	1328 x 928 x 1194
Crated Volume m <sup>3</sup>	
KM-590DJE- R452	0,93
B-340 SA	1,25
Crated weight (kg)	
B 340 SA	88
Refrigerant	R452/1,900g



Model	Ice cube type	Condenser	Production up to kg (24h) air 10°C / water 10°C	Production up to kg (24h) air 21°C / water 15°C	Electrical specs V/Hz/Ph	Power rating (W)	Net weight / gross (kg)	ITEM
KMD-590DJE - R452	Crescent	Air	630	590	220-240/50/1	2090	136/151	M096



# DCM Range

## Ecological Cubelet ice- and water dispensers



### DCM-60 KE - HC (P)

<b>Net Dimensions (mm)</b>	350 x 585 x 695 (max 710 mm)
<b>Ice Storage capacity up to (kg)</b>	1.9
<b>Available with:</b>	Lever Push button (Model P)
<b>Crated dimensions (mm)</b>	440 x 655 x 906
<b>Crated Volume (m<sup>3</sup>)</b>	0,26
<b>Refrigerant</b>	R290



Model	Ice cube type	Condenser	Production up to kg (24h) air 10°C / water 10°C	Production up to kg (24h) air 21°C / water 15°C	Electrical specs V/Hz/Ph	Power rating (W)	Net weight / gross (kg)	ITEM
<b>DCM-60 KE-HC</b>	Cubelet +Water	Air	<b>60</b>	<b>50</b>	220-240/50/1	280	47/56	<b>L030</b>
<b>DCM-60 KE HC-P</b>	Cubelet +Water	Air	<b>60</b>	<b>50</b>	220-230/50/1	280	47/56	<b>L031</b>

DCM-60 KE P - model with push button (on request)

### DCM-120 KE (P) - HC

<b>Net Dimensions (mm)</b>	350 x 585 x 815 (max 830 mm)
<b>Ice Storage capacity up to (kg)</b>	4
<b>Available with:</b>	Lever Push button (Model P)
<b>Crated dimensions (mm)</b>	440 x 655 x 1026
<b>Crated Volume (m<sup>3</sup>)</b>	0,30
<b>Refrigerant</b>	R290



Model	Ice cube type	Condenser	Production up to kg (24h) air 10°C / water 10°C	Production up to kg (24h) air 21°C / water 15°C	Electrical specs V/Hz/Ph	Power rating (W)	Net weight / gross (kg)	Euro
<b>DCM-120 KE-HC</b>	Cubelet +Water	Air	<b>125</b>	<b>105</b>	220-240/50/1	400	55/64	<b>L032</b>
<b>DCM-120 KE- P-HC</b>	Cubelet +Water	Air	<b>125</b>	<b>105</b>	220-230/50/1	400	55/64	<b>L033</b>

DCM-120 KE P - model with push button (on request)



# DCM Range

## Cubelet ice and water dispensers



### DCM-60 KE (P)

<b>Net Dimensions (mm)</b>	350 x 585 x 695 (max 710 mm)
<b>Ice Storage capacity</b>	1,9
<b>Available with:</b>	Lever Push button (Model P)
<b>Crated dimensions (mm)</b>	440 x 655 x 906
<b>Crated Volume (m<sup>3</sup>)</b>	0,26
<b>Refrigerant</b>	R134a-F-gas CO <sub>2</sub> eq: 300 kg



DCM-60 KE P - model with push button (on request)

Model	Ice cube type	Condenser	Production up to kg (24h) air 10°C / water 10°C	Production up to kg (24h) air 21°C / water 15°C	Electrical specs V/Hz/Ph	Power rating (W)	Net weight / gross (kg)	ITEM
<b>DCM-60KE(EU)</b>	Cubelet +Water	Air	<b>60</b>	<b>50</b>	220-240/50/1	280	47/56	<b>L013</b>
<b>DCM-60KE-P (EU)</b>	Cubelet +Water	Air	<b>60</b>	<b>50</b>	220-230/50/1	280	47/56	<b>L014</b>
<b>DCM-60KE (G60)</b>	Cubelet +Water	Air	<b>60</b>	<b>50</b>	230V/60Hz/1	280	47/56	<b>L013-C130</b>
<b>DCM-60KE-P (G60)</b>	Cubelet +Water	Air	<b>60</b>	<b>50</b>	230V/60Hz/1	280	47/56	<b>L014-C130</b>

### DCM-120 KE (P)

<b>Net Dimensions (mm)</b>	350 x 585 x 695 (max 710 mm)
<b>Ice Storage capacity up to (kg)</b>	4
<b>Available with:</b>	Lever Push button (Model P)
<b>Crated dimensions (mm)</b>	440 x 655 x 906
<b>Crated Volume (m<sup>3</sup>)</b>	0,26
<b>Refrigerant</b>	R134a-F-gas CO <sub>2</sub> eq: 300 kg



Model	Ice cube type	Condenser	Production up to kg (24h) air 10°C / water 10°C	Production up to kg (24h) air 21°C / water 15°C	Electrical specs V/Hz/Ph	Power rating (W)	Net weight / gross (kg)	ITEM
<b>DCM-120 KE</b>	Cubelet +Water	Air	<b>125</b>	<b>105</b>	220-240/50/1	280	47/56	<b>L009</b>
<b>DCM-120 KE-P</b>	Cubelet +Water	Air	<b>125</b>	<b>105</b>	220-230/50/1	280	47/56	<b>L010</b>

DCM-120 KE P - model with push button (on request)



# DIM Range

## Ecological Large Cube ice dispenser



### DIM-40 DE-HC

Net dimensions (mm)	350 x 526 x 1590 (legs + 90 mm)
Ice Storage capacity up to (kg)	15
Crated dimensions (mm)	450 x 670 x 1763
Crated Volume (m <sup>3</sup> )	0,53
Refrigerant	R290



Model	Ice cube type	Condenser	Production up to kg (24h) air 10°C / water 10°C	Production up to kg (24h) air 21°C / water 15°C	Electrical specs V/Hz/Ph	Power rating (W)	Net weight / gross (kg)	ITEM
DIM-40 DE-HC	Large Cube	Air	39	34	220-240/50/1	280	59/70	L024



# DIM Range

## Large Cube ice dispenser



### DIM-30 DE-2

Net dimensions (mm)	350 x 526 x 1590 (legs + 45 mm)
Ice Storage capacity up to (kg)	15
Crated dimensions (mm)	450 x 730 x 1666
Crated Volume (m <sup>3</sup> )	0,55
Refrigerant	R134a/200g



Model	Ice cube type	Condenser	Production up to kg (24h) air 10°C / water 10°C	Production up to kg (24h) air 21°C / water 15°C	Electrical specs V/Hz/Ph	Power rating (W)	Net weight / gross (kg)	ITEM
DIM-30 DE-2	Large Cube	Air	40/42	36	220-240/50/1		65/80	E2HA-D010



# DCM-DSM Range

## Shuttle cube ice and water dispenser



### DSM-12 DE

Net dimensions (mm)	180 x 527 x 695
Ice Storage capacity up to (kg)	3
Crated dimensions (mm)	224 x 620 x 748
Crated Volume (m <sup>3</sup> )	0,13
Refrigerant	R134a-F-gas CO <sub>2</sub> eq: 114 kg



Model	Ice cube type	Condenser	Production up to kg (24h) air 10°C / water 10°C	Production up to kg (24h) air 21°C / water 15°C	Electrical specs V/Hz/Ph	Power rating (W)	Net weight / gross (kg)	Euro
DSM-12 DE	Shuttle 3 g	Air	13	11	220-240/50/1	200	26/28	L016-C401



Perfectly poured beer at the touch of a button

# BEERMATIC

## DUAL TAP

Automated Draft beer Dispenser



**BEERMATIC DUAL TAP**  
Automated Draft beer Dispenser

### DBF-AS65WE-EU-HC

Dimensions (mm) 367 x 674 x 764

**Instant Output** -after initial freeze down - 65 ltr.  
-after 45' recovery time-76 ltr.

**Flow Rate. Recovery Time** 4 glasses/60" @ 453 ml  
10.2 ltr. every 45'

**Crated dimensions (mm)** 466 x 795 x 858

**Crated volume (m<sup>3</sup>)** 0,317

**Refrigerant** R600a (80g)



### DBF-AS65WE-EU

Dimensions (mm) 367 x 674 x 764

**Instant Output** -after initial freeze down - 65 ltr.  
-after 45' recovery time-76 ltr.

**Flow Rate. Recovery Time** 4 glasses/60" @ 453 ml  
10.2 ltr. every 45'

**Crated dimensions (mm)** 466 x 795 x 858

**Crated volume (m<sup>3</sup>)** 0,317

**Refrigerant** R134a-CO<sub>2</sub> eq; 175 g

Model	Condenser	Electrical specs V/Hz/Ph	Power rating (W)	Net weight / gross (kg)	Euro
DBF-AS65WE-EU-HC	Air	220-240/50/1	285	50/56	B078-C101
DBF-AS65WE-EU	Air	220-240/50/1	285	50/56	B078-D011

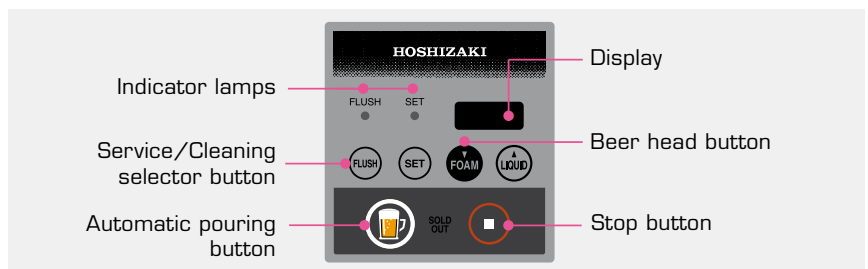

The draft beer dispenser is compatible with glasses of 50 mm or over in inside diameter and 105 mm or less in outside diameter.

There must be a difference of 20 mm or over in height between a large size glass and a medium size glass.

If you use glasses or tumblers of other sizes, please consult our installation manual.

# Ice storage bins and transport systems



## Ice Storages with ABS door

Model	Ice storage capacity up to (kg)	Dimensions W x D x H (mm)	Crated dimensions W x D x H (mm)	Net weight / gross (kg)	Crated Volume (m <sup>3</sup> )	ITEM
<b>B-140SA</b>	<b>140</b>	560 x 820 x 1016 (+90 legs)	940 x 760 x 1190	37 / 49	0,75	<b>G014</b>
<b>B-210SA</b>	<b>210</b>	781 x 820 x 1016 (+90 legs)	940 x 900 x 1190	47 / 57	1,0	<b>G015</b>
<b>B-340SA</b>	<b>340</b>	1220 x 820 x 1016 (+90 legs)	1360 x 940 x 1190	64 / 86	1,5	<b>G016</b>



**DIVIDER FOR B-340SA BIN**

**S-31833**

## Ice Storages with steel door

Model	Ice storage capacity up to (kg)	Dimensions W x D x H (mm)	Crated dimensions W x D x H (mm)	Net weight / gross (kg)	Crated Volume (m <sup>3</sup> )	ITEM
<b>F-300-22</b>	<b>137</b>	559 x 801 x 1067 (legs included)	680 x 820 x 1020	- / 58	0,7	<b>E300-22</b>
<b>F-425-30</b>	<b>197</b>	762 x 801 x 1041 (legs included)	900 x 840 x 1040	- / 74	0,80	<b>F425S</b>
<b>F-600-42S</b>	<b>258</b>	1087 x 686 x 1019 (legs included)	1200 x 900 x 1000	- / 70	1,1	<b>F600S</b>
<b>F-650-44S</b>	<b>296</b>	1118 x 801 x 1016 (legs included)	1200 x 900 x 1020	- / 80	1,1	<b>F650S</b>
<b>F-950-48S</b>	<b>429</b>	1220 x 801 x 1270 (legs included)	1400 x 900 x 1280	- / 96	1,6	<b>F950S</b>
<b>F-1025-52S</b>	<b>464</b>	1320 x 800 x 1270 (legs included)	1400 x 900 x 1280	- / 112	1,6	<b>F1025S</b>



# Ice storage bins and transport systems



## ITS ice storage and transport systems

Model	Ice storage capacity up to (kg)	Dimensions W x D x H (mm)	Crated dimensions W x D x H (mm)	Net weight / gross (kg)	Crated Volume (m <sup>3</sup> )	ITEM
ITS-100-31	46 (+109 cart)	788 x 1016 x 1180	1320 x 910 x 1420	70 / 110	1,7	ITS100
ITS-500-31	227 (+109 cart)	788 x 1016 x 1524 LQ Base - 1320 x 910 x 1200	1320 x 910 x 750	- / 75+91	0,9+1,4	ITS500-31
ITS-600-31	273 (+109 cart)	788 x 1016 x 1702 LQ Base - 1320 x 910 x 1200	1320 x 910 x 890	- / 85+91	1,1+1,4	ITS600-NS
ITS-700-31	320 (+109 cart)	788 x 1016 x 1905 LQ Base - 1320 x 910 x 1200	1320 x 910 x 1100	- / 96+91	1,3+1,4	ITS700-31
ITS-1350 SG-60	612 (+109+109 2 carts)	1524 x 1219 x 1900 LQ Base - 1640 x 1320 x 1200	1640 x 1320 x 1070	- / 210+180	2,3+2,6	ITS1350
ITS-2250 SG-60	1494 (+109+109 2 carts)	2236 x 1219 x 2460 1640 x 1320 x 1200	1700 x 1320 x 1800	- / 240+180	4,0+2,6	ITS2250
Smart Cart 75 / ITS Cart	109	610 x 1054 x 908	TBA	- / 32	IVD	Smart Cart 75
Ice buckets for ITS (set of six)	12 kg each bucket	181 x 423 x 381	TBA	- / 16 (6 totes)	IVD	ICE TOTE
SMART 75 CART	34 (contains 3 buckets)	547 x 801 x 991	-	-	24	SMART-CART75

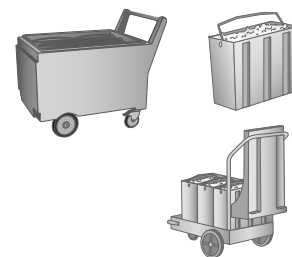

## Ice storages and transport systems SG

Model	Ice storage capacity up to (kg)	Dimensions W x D x H (mm)	Crated dimensions W x D x H (mm)	Net weight / gross (kg)	Crated Volume (m <sup>3</sup> )	ITEM
SG-500-30	209	762 x 788 x 1093	900 x 840 x 1100	- / 80	2,12	SG500
SG-700-30	308	1118 x 889 x 1524	1067 x 1651 x 1168	110 / 130	2,06	SG700

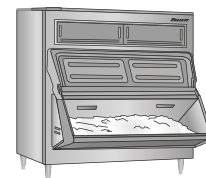

## Ice storages and transport systems DEV

Model	Ice storage capacity up to (kg)	Dimensions W x D x H (mm)	Crated dimensions W x D x H (mm)	Net weight / gross (kg)	Crated Volume (m <sup>3</sup> )	ITEM
DEV-500 SG-30-75	209	762 x 788 x 1575	1320 x 910 x 1100 LQ 30 - 900 x 840 x 770	125 / 100+60	1,3+0,58	DEV500SG
DEV-700 SG-30-75	308	762 x 788 x 1969	1118 x 914 x 1473 LQ 30 - 914 x 864 x 787	131 / 177	1,5+0,62	DEV700SG



# Kit for matching ice makers and storage containers

Some combinations of container / ice maker may require a Cover Kit. Please check the following table for possible combinations. If you wish to combine one of our containers with other branded ice Kit containers, consult us to see if it is possible to use other Cover Kits.

## Top Kits

TK4 DM	TK 18 D	Divider for B-340 SA	S-31833
TK4 DR	TK IMD2	Center Partition	SEPARTOR
TK 8 D	TOP KIT (HE) - FM1800	S-31707	

## Kit for matching ice makers and ice storage bins

Quantity	Ice maker model	B-140 SA	B-210 SA	B-340 SA
	IM-130A/-HC	-	TK 8 D	TK 8 D + TK 18 D
	IM-240D	n.a.	n.a.	TK IMD2
	IM-240A/-HC	-	TK 8 D	TK 8 D + TK 18 D
	KM-520/660	-	TK 8 D	TK 8 D + TK 18 D
	KM-1301	n.a.	n.a.	-
	KMD-201	-	TK 8 D	TK 8 D + TK 18 D
	KMD-270	-	TK 8 D	TK 8 D + TK 18 D
	FM-150	-	TK 8 D	TK 8 D + TK 18 D
	FM-300/-HC	-	TK 8 D	TK 8 D + TK 18 D
	FM-480/-HC	-	TK 8 D	TK 8 D + TK 18 D
	FM-600	-	TK 8 D	TK 8 D + TK 18 D
	FM-750	n.a.	-	TK 18 D
	FM-1000	n.a.	-	TK 18 D
	FM-1200	n.a.	-	TK 18 D
	FM-1800	n.a.	n.a.	TK 1800
2x	IM-240A	n.a.	n.a.	TK 4 DM
2x	KM-520/660	n.a.	n.a.	TK 4 DM
2x	KMD-201	n.a.	n.a.	TK 4 DM + TK 4 DR
2x	KMD-270	n.a.	n.a.	TK 4 DM + TK 4 DR
2x	KMD-470	n.a.	TK-30	TK-30 + TK-18D
2x	KMD-590	n.a.	n.a.	TK-48
2x	FM-150	n.a.	n.a.	TK 4 DM
2x	FM-300	n.a.	n.a.	TK 4 DM
2x	FM-480	n.a.	n.a.	TK 4 DM
2x	FM-600	n.a.	n.a.	TK 4 DM

- = Perfect combination - matching between ice maker and bin, no top kit required

n.a. = Combination of ice maker and bin is not possible

## Ice Crusher

### Ice Crusher C-103

Net dimensions (mm)	180 x 330 x 320
Ice Storage capacity up to (kg)	1
Crated dimensions (mm)	TBA
Crated Volume (m <sup>3</sup> )	TBA



Crushing capacity (kg/min)	Electrical specs V/Hz/Ph	Power rating (kW)	Net weight / gross (kg)	ITEM
3	220-240/50/1	0,15	10	C103

### Ice Crusher C-105



Net dimensions (mm)	370 x 310 x 510
Ice Storage capacity up to (kg)	5
Crated dimensions (mm)	TBA
Crated Volume (m <sup>3</sup> )	TBA



Crushing capacity (kg/min)	Electrical specs V/Hz/Ph	Power rating (kW)	Net weight / gross (kg)	ITEM
5	220-240/50/1	0,15	25	C105

# Water treatment systems

**0.5 micron MEMBRANE SYSTEM with activated carbon and Hoshizaki Universal Head connection.** Contains polyphosphates for food use that inhibit the accumulation of limescale.

<p><b>Complete kit First installation SINGLE CARTRIDGE</b> Including hydraulic fittings</p> 	<p><b>4HC-H Single Cartridge</b> 0.5 micron membrane, with activated carbon Flow rate 7.5 L / Minute Total water treatment capacity: 95K liters Min-max water temperature: 2 ° -38 ° C Min-max water pressure: 0.7-8.6 bar For cold water only. It reduces water taste and odor problems, as well as impurities and rust. Finally, it limits the passage or growth of bacteria potentially present in the incoming water. 1/2 "pipe to and from the filters. Up to 225 kg of ice in 24 hours: Hoshizaki Single System - 4HC-H</p>	<p><b>To be used with:</b></p> <ul style="list-style-type: none"> <li>• IM 21 - IM 30 - IM 45 - IM 65 - IM100;</li> <li>• DIM 30 - DIM40</li> <li>• KM 40 - KM 55 - KM 80 - KM 115 - KM 140</li> <li>• FM 80 - 150</li> <li>• DCM 60 DCM 120</li> </ul>	<p><b>Complete kit first installation DOUBLE CARTRIDGE</b> Including hydraulic fittings</p> 	<p><b>4HC-H Single Cartridge in Double System</b> 0.5 micron membrane, with activated carbon Total flow 15 L / Minute Total volume of treated water 190K liters Min-max water temperature: 2 ° -38 ° C Min-max water pressure: 0.7-8.6 bar For cold water only. It reduces water taste and odor problems, as well as impurities and rust. Finally, it limits the passage or growth of bacteria potentially present in the incoming water. 1/2 "pipe to and from the filters. Up to 410 kg of ice in 24 hours: Double Hoshizaki System - 4HC-H</p>	<p><b>To be used with:</b></p> <ul style="list-style-type: none"> <li>• IM 130 - IM240</li> <li>• KM 210 - KM270 - KM 470 KM590</li> <li>• FM300 - FM480 - FM600 FM750- FM1000 - FM1200 FM1800</li> </ul>
---	---	---	---	---	---

**0.5 micron CARBONLESS™ MEMBRANE SYSTEM without activated carbon and Hoshizaki Universal Head connection.** Contains polyphosphates for food use which inhibit the accumulation of limescale.

<p><b>Kit first installation SINGLE CARTRIDGE</b> Including hydraulic fittings</p> 	<p><b>Carbonless 80 m³ KIT 0.5 WFC 80K H-S</b> up to 7.6 liters per minute Suggested duration of use: 12 months</p>	<p><b>To be used with:</b></p> <ul style="list-style-type: none"> <li>• IM 21 - IM 30 - IM 45 - IM 65 - IM100;</li> <li>• DIM 30 - DIM40</li> <li>• KM 40 - KM 55 - KM 80 - KM 115 - KM 140</li> <li>• FM 80 - 150</li> <li>• DCM 60 DCM 120</li> </ul>	<p><b>First installation kit DOUBLE CARTRIDGE</b> Including hydraulic fittings</p> 	<p><b>Carbonless 160 m³ (80 m³ x 2) = 160 m³ KIT 2x 0.5 WFC 80K H-S</b> up to 7.6 liters per minute Suggested duration of use: 12 months</p>	<p><b>To be used with:</b></p> <ul style="list-style-type: none"> <li>• IM 130 - IM240</li> <li>• KM 210 - KM270 - KM 470 KM590</li> <li>• FM300 - FM480 - FM600 FM750- FM1000 - FM1200 FM1800</li> </ul>
--	---	---	--	--	---

The first installation kit includes: **Body or Head Cartridge (s), Fittings an Pipes.**

**CARBONLESS™ nominal 0.2 micron MEMBRANE SYSTEM without activated carbon and 3M connection.** Contains polyphosphates for food use that inhibit the accumulation of limescale.

<p><b>88 m³ first installation kit C-LESS 0.2NL AB WFC 88K S-SR</b> up to 7.6 liters per minute Suggested duration of use: 12 months</p> <p>- Antibacterial membrane absolute IMPACT for hospital use</p> 	<p><b>124 m³ first installation kit C-LESS 0.2NL WFC 124K S-SR</b> up to 340 kg of ice in 24h</p> 	<p><b>197 m³ first installation kit C-LESS 0.2NL WFC 197K S-SR</b> up to 540 kg of ice in 24h</p> 	<p><b>270 m³ first installation kit C-LESS 0.2NL WFC 270K S-SR</b> up to 740 kg of ice in 24h</p> 	<p><b>416 m³ first installation kit C-LESS C-LESS 0.2NL WFC 416K S-SR</b> up to 1140 kg of ice in 24h</p> 
---	---	---	---	---

The first installation kit includes: **Connection, Cartridge and Fittings.**

## REPLACEMENT CARTRIDGES

Cartridges WITH MEMBRANE AND ACTIVATED CARBON attack HOSHIZAKI UNIVERSAL HEAD		
MODEL	TOT. LITERS	EURO PACKAGE
CART HC Single	95 m³	12 pcs
CART HC Twin	190 m³	12 pcs

HOSHIZAKI UNIVERSAL HEAD CARBON-FREE CARBON-FREE MEMBRANE cartridges		
MODEL	TOT. LITERS	EURO PACKAGE
0.5 WFC 80K H-S	80 m³	12 pcs

## ATTACKS

### HOSHIZAKI UNIVERSAL HEAD ATTACK

CONNECTION 3M with thread  
HZ-VH3-BSP - HF 3/8 "series  
female

CONNECTION 3M with fittings  
"John Guest"  
VH3-3 / 8 "Joh Guest-A5

### Cartridges WITH MEMBRANE and WITHOUT ACTIVATED CARBONS FOR 3M ATTACHMENT

MODEL	TOT. LITERS	PACKAGE
0.2 AB WFC 88K S-SR	88 m³	12 pcs
C-LESS 0.2NL WFC 124K S-SR	124 m³	6 pcs
C-LESS 0.2NL WFC 197K S-SR	197 m³	2 pcs
C-LESS 0.2NL WFC 270K S-SR	270 m³	n.a.
C-LESS 0.2NL WFC 416K S-SR	416 m³	n.a.

## REPLACEMENT CARTRIDGE

MEMBRANE AND CARBON SYSTEMS ACTIVE, UNIVERSAL HOSHIZAKI HEAD	
CART HC Single	45.000 liters
CART HC Twin	90.000 liters
CART HC Triple	130.000 liters







# HOSHIZAKI

## Hoshizaki Europe BV

### Export department

Burgemeester Stramanweg 101  
1101 AA Amsterdam  
Noord-Holland  
The Netherlands

T. +31 (0)20 5650429

Email: [sales@hoshizaki.nl](mailto:sales@hoshizaki.nl)

[www.hoshizaki-europe.com](http://www.hoshizaki-europe.com)

Your trusted Hoshizaki dealer

---

 [@hoshizaki\\_gram](https://twitter.com/hoshizaki_gram)

 [Hoshizaki Europe \(EMENA\)](https://www.linkedin.com/company/hoshizaki-europe)

**Models and technical specifications may change without notice.**