

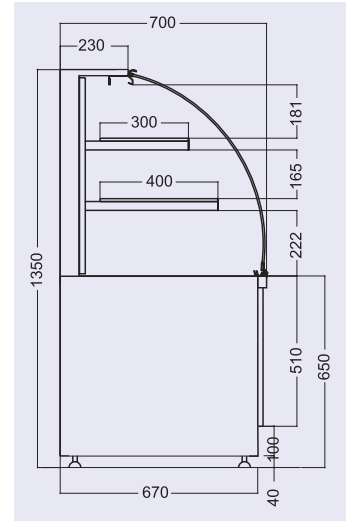

ETD-11C10
Curved Glass Display Unit
COLD



!See page 168 for front decor and table options.

Cold

TYPE	CODE	MODEL	L	W	H	POWER	TEMP.	WEIGHT	VOLTAGE	CAPACITY	PRICE
ETD-11C10	7ETD.11C10.SS	ELEC	1000	700	1350	0.7 kW - MF	+4 / +6 °C	190 kg.	220V / 50 Hz.	240 lt.	
ETD-11C12	7ETD.11C12.SS	ELEC	1200	700	1350	0.7 kW - MF	+4 / +6 °C	225 kg.	220V / 50 Hz.	290 lt.	
ETD-11C15	7ETD.11C15.SS	ELEC	1500	700	1350	0.8 kW - MF	+4 / +6 °C	285 kg.	220V / 50 Hz.	360 lt.	
ETD-11C18	7ETD.11C18.SS	ELEC	1800	700	1350	0.9 kW - MF	+4 / +6 °C	340 kg.	220V / 50 Hz.	430 lt.	
ETD-11C20	7ETD.11C20.SS	ELEC	2000	700	1350	0.9 kW - MF	+4 / +6 °C	375 kg.	220V / 50 Hz.	480 lt.	

COLD
COLD
COLD
COLD
COLD

Hot

TYPE	CODE	MODEL	L	W	H	POWER	TEMP.	WEIGHT	VOLTAGE	CAPACITY	PRICE
ETD-11H10	7ETD.11H10.SS	ELEC	1000	700	1350	3.5 kW - MF	+30/+90 °C	181 kg.	220V / 50 Hz.	240 lt.	
ETD-11H12	7ETD.11H12.SS	ELEC	1200	700	1350	3.5 kW - MF	+30/+90 °C	201 kg.	220V / 50 Hz.	290 lt.	
ETD-11H15	7ETD.11H15.SS	ELEC	1500	700	1350	3.5 kW - MF	+30/+90 °C	256 kg.	220V / 50 Hz.	360 lt.	
ETD-11H18	7ETD.11H18.SS	ELEC	1800	700	1350	5.0 kW - MF	+30/+90 °C	296 kg.	220V / 50 Hz.	430 lt.	
ETD-11H20	7ETD.11H20.SS	ELEC	2000	700	1350	5.0 kW - MF	+30/+90 °C	351 kg.	220V / 50 Hz.	480 lt.	

HOT
HOT
HOT
HOT
HOT

Neutral

TYPE	CODE	MODEL	L	W	H	POWER	TEMP.	WEIGHT	VOLTAGE	CAPACITY	PRICE
ETD-11N10	7ETD.11N10.SS	ELEC	1000	700	1350	0,05 kW - MF	-	179 kg.	220V / 50 Hz.	240 lt.	
ETD-11N12	7ETD.11N12.SS	ELEC	1200	700	1350	0,05 kW - MF	-	199 kg.	220V / 50 Hz.	290 lt.	
ETD-11N15	7ETD.11N15.SS	ELEC	1500	700	1350	0,05 kW - MF	-	254 kg.	220V / 50 Hz.	360 lt.	
ETD-11N18	7ETD.11N18.SS	ELEC	1800	700	1350	0,06 kW - MF	-	294 kg.	220V / 50 Hz.	430 lt.	
ETD-11N20	7ETD.11N20.SS	ELEC	2000	700	1350	0,06 kW - MF	-	349 kg.	220V / 50 Hz.	480 lt.	

NOTR
NOTR
NOTR
NOTR
NOTR



ETD-12C10
Flat Glass Display Unit
COLD

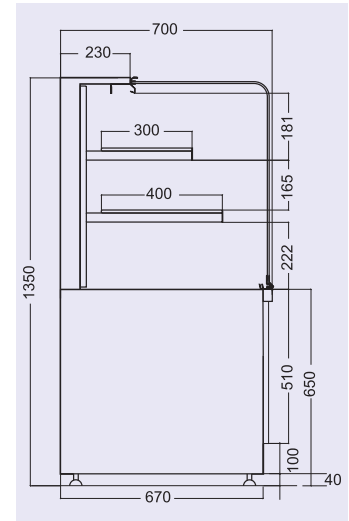

!See page 168 for front decor and table options.

Cold

TYPE	CODE	MODEL	L	W	H	POWER	TEMP.	WEIGHT	VOLTAGE	CAPACITY	PRICE
ETD-12C10	7ETD.12C10.SS	ELEC	1000	700	1350	0.7 kW - MF	+4 / +6 °C	190 kg.	220V / 50 Hz.	240 lt.	
ETD-12C12	7ETD.12C12.SS	ELEC	1200	700	1350	0.7 kW - MF	+4 / +6 °C	225 kg.	220V / 50 Hz.	290 lt.	
ETD-12C15	7ETD.12C15.SS	ELEC	1500	700	1350	0.8 kW - MF	+4 / +6 °C	285 kg.	220V / 50 Hz.	360 lt.	
ETD-12C18	7ETD.12C18.SS	ELEC	1800	700	1350	0.9 kW - MF	+4 / +6 °C	340 kg.	220V / 50 Hz.	430 lt.	
ETD-12C20	7ETD.12C20.SS	ELEC	2000	700	1350	0.9 kW - MF	+4 / +6 °C	375 kg.	220V / 50 Hz.	480 lt.	

COLD
COLD
COLD
COLD
COLD

Hot

TYPE	CODE	MODEL	L	W	H	POWER	TEMP.	WEIGHT	VOLTAGE	CAPACITY	PRICE
ETD-12H10	7ETD.12H10.SS	ELEC	1000	700	1350	3.5 kW - MF	+30 / +90 °C	181 lt.	220V / 50 Hz.	240 lt.	
ETD-12H12	7ETD.12H12.SS	ELEC	1200	700	1350	3.5 kW - MF	+30 / +90 °C	201 lt.	220V / 50 Hz.	290 lt.	
ETD-12H15	7ETD.12H15.SS	ELEC	1500	700	1350	3.5 kW - MF	+30 / +90 °C	256 lt.	220V / 50 Hz.	360 lt.	
ETD-12H18	7ETD.12H18.SS	ELEC	1800	700	1350	5.0 kW - MF	+30 / +90 °C	296 lt.	220V / 50 Hz.	430 lt.	
ETD-12H20	7ETD.12H20.SS	ELEC	2000	700	1350	5.0 kW - MF	+30 / +90 °C	351 lt.	220V / 50 Hz.	480 lt.	

HOT
HOT
HOT
HOT
HOT

Neutral

TYPE	CODE	MODEL	L	W	H	POWER	TEMP.	WEIGHT	VOLTAGE	CAPACITY	PRICE
ETD-12N10	7ETD.12N10.SS	ELEC	1000	700	1350	0.05 kW - MF	-	179 kg.	220V / 50 Hz.	240 lt.	
ETD-12N12	7ETD.12N12.SS	ELEC	1200	700	1350	0.05 kW - MF	-	199 kg.	220V / 50 Hz.	290 lt.	
ETD-12N15	7ETD.12N15.SS	ELEC	1500	700	1350	0.05 kW - MF	-	254 kg.	220V / 50 Hz.	360 lt.	
ETD-12N18	7ETD.12N18.SS	ELEC	1800	700	1350	0.06 kW - MF	-	294 kg.	220V / 50 Hz.	430 lt.	
ETD-12N20	7ETD.12N20.SS	ELEC	2000	700	1350	0.06 kW - MF	-	349 kg.	220V / 50 Hz.	480 lt.	

NOTR
NOTR
NOTR
NOTR
NOTR



ETD-13C10
Bent Glass Display Unit
COLD

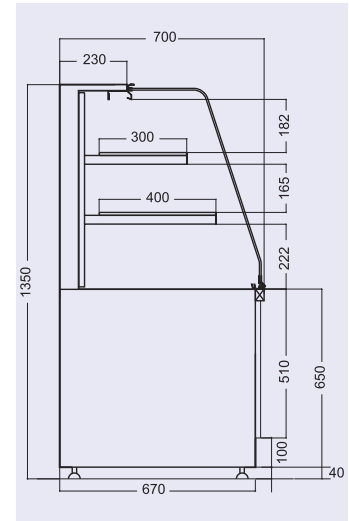

!See page 168 for front decor and table options.

Cold

TYPE	CODE	MODEL	L	W	H	POWER	TEMP.	WEIGHT	VOLTAGE	CAPACITY	PRICE
ETD-13C10	7ETD.13C10.SS	ELEC	1000	700	1350	0.7 kW - MF	+4 / +6 °C	190 kg.	220V. / 50Hz.	240 lt.	
ETD-13C12	7ETD.13C12.SS	ELEC	1200	700	1350	0.7 kW - MF	+4 / +6 °C	225 kg.	220V. / 50Hz.	290 lt.	
ETD-13C15	7ETD.13C15.SS	ELEC	1500	700	1350	0.8 kW - MF	+4 / +6 °C	285 kg.	220V. / 50Hz.	360 lt.	
ETD-13C18	7ETD.13C18.SS	ELEC	1800	700	1350	0.9 kW - MF	+4 / +6 °C	340 kg.	220V. / 50Hz.	430 lt.	
ETD-13C20	7ETD.13C20.SS	ELEC	2000	700	1350	0.9 kW - MF	+4 / +6 °C	375 kg.	220V. / 50Hz.	480 lt.	

COLD
COLD
COLD
COLD
COLD

Hot

TYPE	CODE	MODEL	L	W	H	POWER	TEMP.	WEIGHT	VOLTAGE	CAPACITY	PRICE
ETD-13H10	7ETD.13H10.SS	ELEC	1000	700	1350	3.5 kW - MF	+30 / +90 °C	181 kg.	220V. / 50Hz.	240 lt.	
ETD-13H12	7ETD.13H12.SS	ELEC	1200	700	1350	3.5 kW - MF	+30 / +90 °C	201 kg.	220V. / 50Hz.	290 lt.	
ETD-13H15	7ETD.13H15.SS	ELEC	1500	700	1350	3.5 kW - MF	+30 / +90 °C	256 kg.	220V. / 50Hz.	360 lt.	
ETD-13H18	7ETD.13H18.SS	ELEC	1800	700	1350	5.0 kW - MF	+30 / +90 °C	296 kg.	220V. / 50Hz.	430 lt.	
ETD-13H20	7ETD.13H20.SS	ELEC	2000	700	1350	3.5 kW - MF	+30 / +90 °C	351 kg.	220V. / 50Hz.	480 lt.	

HOT
HOT
HOT
HOT
HOT

Neutral

TYPE	CODE	MODEL	L	W	H	POWER	TEMP.	WEIGHT	VOLTAGE	CAPACITY	PRICE
ETD-13N10	7ETD.13N10.SS	ELEC	1000	700	1350	0.05 kW - MF	-	179 kg.	220V. / 50Hz.	240 lt.	
ETD-13N12	7ETD.13N12.SS	ELEC	1200	700	1350	0.05 kW - MF	-	199 kg.	220V. / 50Hz.	290 lt.	
ETD-13N15	7ETD.13N15.SS	ELEC	1500	700	1350	0.05 kW - MF	-	254 kg.	220V. / 50Hz.	360 lt.	
ETD-13N18	7ETD.13N18.SS	ELEC	1800	700	1350	0.06 kW - MF	-	294 kg.	220V. / 50Hz.	430 lt.	
ETD-13N20	7ETD.13N20.SS	ELEC	2000	700	1350	0.06 kW - MF	-	349 kg.	220V. / 50Hz.	480 lt.	

NOTR
NOTR
NOTR
NOTR
NOTR



ETD-14C10
Tubular Glass Display Unit
COLD

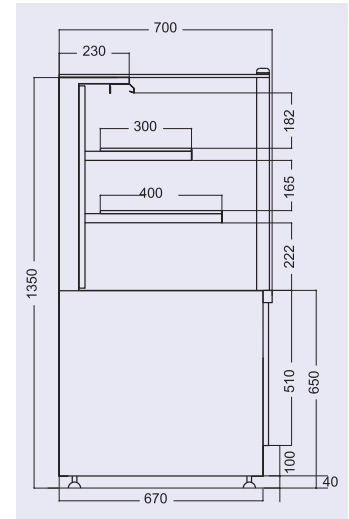

!See page 168 for front decor and table options.

Cold

TYPE	CODE	MODEL	L	W	H	POWER	TEMP.	WEIGHT	VOLTAGE	CAPACITY	PRICE
ETD-14C10	7ETD.14C10.SS	ELEC	1000	700	1350	0.7 kW - MF	+4 / +6 °C	190 kg.	220V. / 50Hz.	240 lt.	
ETD-14C12	7ETD.14C12.SS	ELEC	1200	700	1350	0.7 kW - MF	+4 / +6 °C	225 kg.	220V. / 50Hz.	290 lt.	
ETD-14C15	7ETD.14C15.SS	ELEC	1500	700	1350	0.8 kW - MF	+4 / +6 °C	285 kg.	220V. / 50Hz.	360 lt.	
ETD-14C18	7ETD.14C18.SS	ELEC	1800	700	1350	0.9 kW - MF	+4 / +6 °C	340 kg.	220V. / 50Hz.	430 lt.	
ETD-14C20	7ETD.14C20.SS	ELEC	2000	700	1350	0.9 kW - MF	+4 / +6 °C	375 kg.	220V. / 50Hz.	480 lt.	

COLD
COLD
COLD
COLD
COLD

Hot

TYPE	CODE	MODEL	L	W	H	POWER	TEMP.	WEIGHT	VOLTAGE	CAPACITY	PRICE
ETD-14H10	7ETD.14H10.SS	ELEC	1000	700	1350	5 kW - MF	+30/+90°C	181 kg.	220V. / 50Hz.	240 lt.	
ETD-14H12	7ETD.14H12.SS	ELEC	1200	700	1350	5 kW - MF	+30/+90°C	201 kg.	220V. / 50Hz.	290 lt.	
ETD-14H15	7ETD.14H15.SS	ELEC	1500	700	1350	7 kW - MF	+30/+90°C	256 kg.	220V. / 50Hz.	360 lt.	
ETD-14H18	7ETD.14H18.SS	ELEC	1800	700	1350	7 kW - MF	+30/+90°C	296 kg.	220V. / 50Hz.	430 lt.	
ETD-14H20	7ETD.14H20.SS	ELEC	2000	700	1350	7 kW - MF	+30/+90°C	351 kg.	220V. / 50Hz.	480 lt.	

HOT
HOT
HOT
HOT
HOT

Neutral

TYPE	CODE	MODEL	L	W	H	POWER	TEMP.	WEIGHT	VOLTAGE	CAPACITY	PRICE
ETD-14N10	7ETD.14N10.SS	ELEC	1000	700	1350	0.05 kW - MF	-	179 kg.	220V. / 50Hz.	240 lt.	
ETD-14N12	7ETD.14N12.SS	ELEC	1200	700	1350	0.05 kW - MF	-	199 kg.	220V. / 50Hz.	290 lt.	
ETD-14N15	7ETD.14N15.SS	ELEC	1500	700	1350	0.05 kW - MF	-	254 kg.	220V. / 50Hz.	360 lt.	
ETD-14N18	7ETD.14N18.SS	ELEC	1800	700	1350	0.06 kW - MF	-	294 kg.	220V. / 50Hz.	430 lt.	
ETD-14N20	7ETD.14N20.SS	ELEC	2000	700	1350	0.06 kW - MF	-	349 kg.	220V. / 50Hz.	480 lt.	

NOTR
NOTR
NOTR
NOTR
NOTR



ETD-91K06
Working Bench

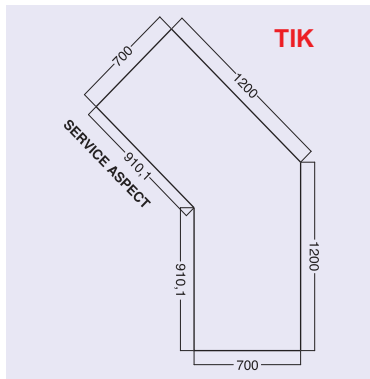
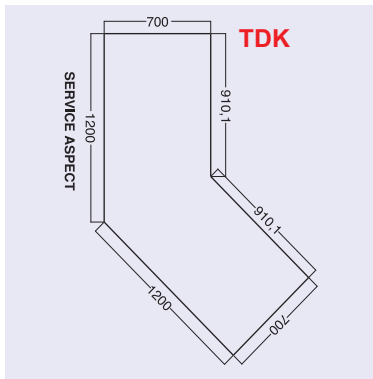
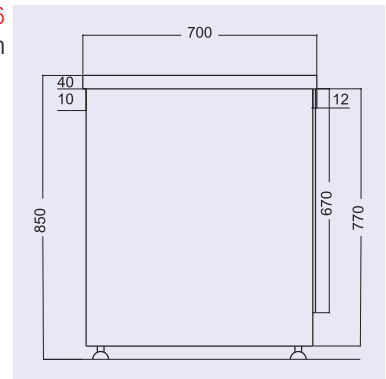

ETD-92TDK
Working Bench

TYPE	CODE	L	W	H	WEIGHT	m ³	PRICE
ETD-91K06	7ETD.91K06.SS	600	700	850	18 kg.	0.40 m ³	
ETD-91K09	7ETD.91K09.SS	900	700	850	21 kg.	0.60 m ³	
ETD-91K12	7ETD.91K12.SS	1200	700	850	24 kg.	0.80 m ³	

TYPE	CODE	L	W	H	WEIGHT	m ³	PRICE
ETD-92TDK	7ETD.92TDK.SS	1200	1200	850	35 kg.	0.40 m ³	
ETD-92TIK	7ETD.92TIK.SS	1200	1200	850	35 kg.	0.60 m ³	

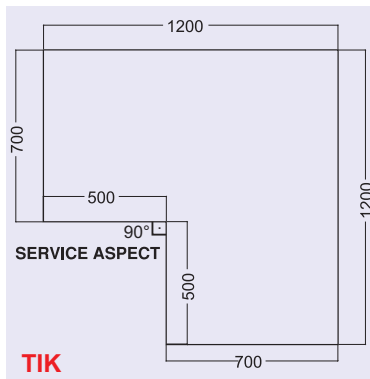
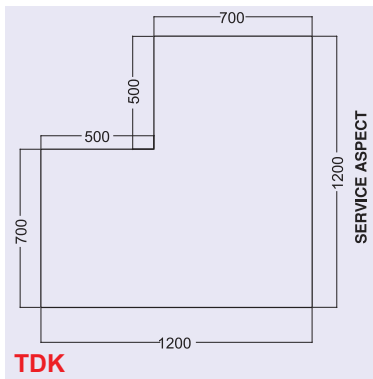

ETD 93TDK
Working Bench

TYPE	CODE	L	W	H	WEIGHT	m ³	PRICE
ETD-93TDK	7ETD.93TDK.SS	1200	1200	850	32 kg.	0.40 m ³	
ETD-93TIK	7ETD.93TIK.SS	1200	1200	850	32 kg.	0.60 m ³	

!See page 164 for front decor and table options.

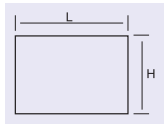

Oak Front Decor

TYPE	CODE	L	W	WEIGHT	m ³	PRICE
ETX-21A10-00	7ETX.21A10.00	1000	470	3.5 kg.	0.04 m ³	
ETX-21A12-00	7ETX.21A12.00	1200	470	4 kg.	0.05 m ³	
ETX-21A15-00	7ETX.21A15.00	1500	470	5 kg.	0.06 m ³	
ETX-21A18-00	7ETX.21A18.00	1800	470	6 kg.	0.07 m ³	
ETX-21A20-00	7ETX.21A20.00	2000	470	7 kg.	0.08 m ³	
bench table						
ETX-22A06-00	7ETX.22A06.00	600	670	2.8 kg.	0.03 m ³	
ETX-22A09-00	7ETX.22A09.00	900	670	4.2 kg.	0.05 m ³	
ETX-22A10-00	7ETX.22A10.00	1000	670	4.7 kg.	0.06 m ³	
ETX-22A12-00	7ETX.22A12.00	1200	670	5.6 kg.	0.07 m ³	
ETX-22A15-00	7ETX.22A15.00	1500	670	7 kg.	0.08 m ³	
ETX-22A18-00	7ETX.22A18.00	1800	670	8.5 kg.	0.09 m ³	
ETX-22A20-00	7ETX.22A20.00	2000	670	9.4 kg.	0.1 m ³	

Marble Table

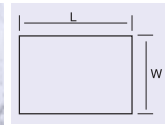

top table

TYPE	CODE	L	W	H	ANGLE AÇI	WEIGHT	m ³	PRICE
ETX-31M10-00	7ETX.31M10.00	1000	250	20	-	22.5 kg.	0.005 m ³	
ETX-31M12-00	7ETX.31M12.00	1200	250	20	-	27 kg.	0.006 m ³	
ETX-31M15-00	7ETX.31M15.00	1500	250	20	-	33.8 kg.	0.007 m ³	
ETX-31M18-00	7ETX.31M18.00	1800	250	20	-	40.5 kg.	0.009 m ³	
ETX-31M20-00	7ETX.31M20.00	2000	250	20	-	45 kg.	0.01 m ³	
bench table								
ETX-32M06-00	7ETX.32M06.00	600	700	20	-	37.8 kg.	0.009 m ³	
ETX-32M09-00	7ETX.32M09.00	900	700	20	-	56.7 kg.	0.013 m ³	
ETX-32M12-00	7ETX.32M12.00	1200	700	20	-	75.6 kg.	0.017 m ³	
ETX-33MDK-00	7ETX.33MDK.00	1200	1200	20	135°	136 kg.	0.055 m ³	
ETX-33MIK-00	7ETX.33MIK.00	1200	1200	20	135°	136 kg.	0.055 m ³	
ETX-34MDK-00	7ETX.33MDK.00	1200	1200	20	90°	110 kg.	0.029 m ³	
ETX-34MIK-00	7ETX.33MIK.00	1200	1200	20	90°	110 kg.	0.029 m ³	

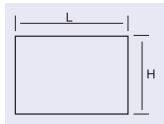

Mahogany Front Decor

TYPE	CODE	L	W	WEIGHT	m ³	PRICE
ETX-21A10-M0	7ETX.21A10.M0	1000	470	3.5 kg.	0.04 m ³	
ETX-21A12-M0	7ETX.21A12.M0	1200	470	4 kg.	0.05 m ³	
ETX-21A15-M0	7ETX.21A15.M0	1500	470	5 kg.	0.06 m ³	
ETX-21A18-M0	7ETX.21A18.M0	1800	470	6 kg.	0.07 m ³	
ETX-21A20-M0	7ETX.21A20.M0	2000	470	7 kg.	0.08 m ³	
bench table						
ETX-22A06-M0	7ETX.22A06.M0	600	670	2.8 kg.	0.03 m ³	
ETX-22A09-M0	7ETX.22A09.M0	900	670	4.2 kg.	0.05 m ³	
ETX-22A10-M0	7ETX.22A10.M0	1000	670	4.7 kg.	0.06 m ³	
ETX-22A12-M0	7ETX.22A12.M0	1200	670	5.6 kg.	0.07 m ³	
ETX-22A15-M0	7ETX.22A15.M0	1500	670	7 kg.	0.08 m ³	
ETX-22A18-M0	7ETX.22A18.M0	1800	670	8.5 kg.	0.09 m ³	
ETX-22A20-M0	7ETX.22A20.M0	2000	670	9.4 kg.	0.1 m ³	

Granite Table

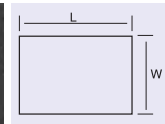

top table

TYPE	CODE	L	W	H	ANGLE AÇI	WEIGHT	m ³	PRICE
ETX-31G10-00	7ETX.31G10.00	1000	250	20	-	22.5 kg.	0.005 m ³	
ETX-31G12-00	7ETX.31G12.00	1200	250	20	-	27 kg.	0.006 m ³	
ETX-31G15-00	7ETX.31G15.00	1500	250	20	-	33.8 kg.	0.007 m ³	
ETX-31G18-00	7ETX.31G18.00	1800	250	20	-	40.5 kg.	0.009 m ³	
ETX-31G20-00	7ETX.31G20.00	2000	250	20	-	45 kg.	0.01 m ³	
bench table								
ETX-32G06-00	7ETX.32G06.00	600	700	20	-	37.8 kg.	0.009 m ³	
ETX-32G09-00	7ETX.32G09.00	900	700	20	-	56.7 kg.	0.013 m ³	
ETX-32G12-00	7ETX.32G12.00	1200	700	20	-	75.6 kg.	0.017 m ³	
ETX-33GDK-00	7ETX.33GDK.00	1200	1200	20	135°	136 kg.	0.055 m ³	
ETX-33GIK-00	7ETX.33GIK.00	1200	1200	20	135°	136 kg.	0.055 m ³	
ETX-34GDK-00	7ETX.34GDK.00	1200	1200	20	90°	110 kg.	0.029 m ³	
ETX-34GIK-00	7ETX.34GIK.00	1200	1200	20	90°	110 kg.	0.029 m ³	

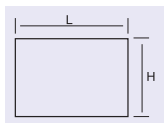

Walnut Front Decor

TYPE	CODE	L	W	WEIGHT	m ³	PRICE
ETX-21A10-W0	7ETX.21A10.W0	1000	470	3.5 kg.	0.04 m ³	
ETX-21A12-W0	7ETX.21A12.W0	1200	470	4 kg.	0.05 m ³	
ETX-21A15-W0	7ETX.21A15.W0	1500	470	5 kg.	0.06 m ³	
ETX-21A18-W0	7ETX.21A18.W0	1800	470	6 kg.	0.07 m ³	
ETX-21A20-W0	7ETX.21A20.W0	2000	470	7 kg.	0.08 m ³	
bench table						
ETX-22A06-W0	7ETX.22A06.W0	600	670	2.8 kg.	0.03 m ³	
ETX-22A09-W0	7ETX.22A09.W0	900	670	4.2 kg.	0.05 m ³	
ETX-22A10-W0	7ETX.22A10.W0	1000	670	4.7 kg.	0.06 m ³	
ETX-22A12-W0	7ETX.22A12.W0	1200	670	5.6 kg.	0.07 m ³	
ETX-22A15-W0	7ETX.22A15.W0	1500	670	7 kg.	0.08 m ³	
ETX-22A18-W0	7ETX.22A18.W0	1800	670	8.5 kg.	0.09 m ³	
ETX-22A20-W0	7ETX.22A20.W0	2000	670	9.4 kg.	0.1 m ³	

Acrylic Table

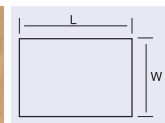
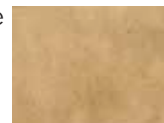

top table

TYPE	CODE	L	W	H	ANGLE AÇI	WEIGHT	m ³	PRICE
ETX-31A10-00	7ETX.31A10.00	1000	250	20	-	22.5 kg.	0.005 m ³	
ETX-31A12-00	7ETX.31A12.00	1200	250	20	-	27 kg.	0.006 m ³	
ETX-31A15-00	7ETX.31A15.00	1500	250	20	-	33.8 kg.	0.007 m ³	
ETX-31A18-00	7ETX.31A18.00	1800	250	20	-	40.5 kg.	0.009 m ³	
ETX-31A20-00	7ETX.31A20.00	2000	250	20	-	45 kg.	0.01 m ³	
bench table								
ETX-32A06-00	7ETX.32A06.00	600	700	20	-	37.8 kg.	0.009 m ³	
ETX-32A09-00	7ETX.32A09.00	900	700	20	-	56.7 kg.	0.013 m ³	
ETX-32A12-00	7ETX.32A12.00	1200	700	20	-	75.6 kg.	0.017 m ³	
ETX-33ADK-00	7ETX.33ADK.00	1200	1200	20	135°	136 kg.	0.055 m ³	
ETX-33AIK-00	7ETX.33AIK.00	1200	1200	20	135°	136 kg.	0.055 m ³	
ETX-34ADK-00	7ETX.34ADK.00	1200	1200	20	90°	110 kg.	0.029 m ³	
ETX-34AIK-00	7ETX.34AIK.00	1200	1200	20	90°	110 kg.	0.029 m ³	



ETX-41T10
Rear Bench



7897.06
Tray Sliding Shelf

TYPE	CODE	L	W	H	WEIGHT	m ³	PRICE
ETX-41T10	7ETX.41T10.SS	1000	300	125	4 kg.	-	
ETX-41T12	7ETX.41T12.SS	1200	300	125	5 kg.	-	
ETX-41T15	7ETX.41T15.SS	1500	300	125	6 kg.	-	
ETX-41T18	7ETX.41T18.SS	1800	300	125	7 kg.	-	
ETX-41T20	7ETX.41T20.SS	2000	300	125	9 kg.	-	

TYPE	CODE	L	W	H	WEIGHT	m ³	PRICE
7897.06	7897.06030.05	600	300	125	4 kg.	-	
7897.09	7897.09030.05	900	300	125	5 kg.	-	
7897.10	7897.10030.05	1000	300	125	6 kg.	-	
7897.12	7897.12030.05	1200	300	125	7 kg.	-	
7897.15	7897.15030.05	1500	300	125	9 kg.	-	
7897.18	7897.18030.05	1800	300	125	7 kg.	-	
7897.20	7897.20030.05	2000	300	125	9 kg.	-	



ETX-10S06
Seperator

TYPE	CODE	L	W	H	HOLE CENTER	WEIGHT	PRICE
ETX-10S06	7ETX.10S06.00	585	60	340	525	8 kg.	
ETX-10S09	7ETX.10S09.00	885	60	340	825	10 kg.	
ETX-10S12	7ETX.10S12.00	1185	60	340	1125	12 kg.	
ETX-10S15	7ETX.10S15.00	1485	60	340	1425	14 kg.	
ETX-10S18	7ETX.10S18.00	1785	60	340	1725	16 kg.	



ETD-25C10 TÜV-CB
Self Service Display Unit /
COLD

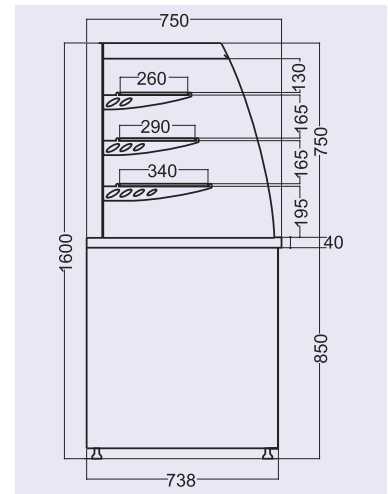

Cold

	TYPE	CODE	MODEL	L	W	H	POWER	TEMP.	WEIGHT	VOLTAGE	CAPACITY	PRICE
	ETD-25C10	7ETD.25C10.SS	ELEC	1000	750	1600	0.7 kW - MF	+4 / +6 °C	195 kg.	220V / 50Hz.	320 lt.	
	ETD-25C12	7ETD.25C12.SS	ELEC	1200	750	1600	1.3 kW - MF	+4 / +6 °C	215 kg.	220V / 50Hz.	390 lt.	
	ETD-25C15	7ETD.25C15.SS	ELEC	1500	750	1600	1.3 kW - MF	+4 / +6 °C	270 kg.	220V / 50Hz.	480 lt.	
	ETD-25C18	7ETD.25C18.SS	ELEC	1800	750	1600	1.3 kW - MF	+4 / +6 °C	310 kg.	220V / 50Hz.	580 lt.	
	ETD-25C20	7ETD.25C20.SS	ELEC	2000	750	1600	1.3 kW - MF	+4 / +6 °C	365 kg.	220V / 50Hz.	640 lt.	

COLD
COLD
COLD
COLD
COLD

Hot

	TYPE	CODE	MODEL	L	W	H	POWER	TEMP.	WEIGHT	VOLTAGE	CAPACITY	PRICE
	ETD-25H10	7ETD.25H10.SS	ELEC	1000	750	1600	3.5 kW - MF	+30 / +90°C	181 kg.	220V / 50Hz.	320 lt.	
	ETD-25H12	7ETD.25H12.SS	ELEC	1200	750	1600	3.5 kW - MF	+30 / +90°C	201 kg.	220V / 50Hz.	390 lt.	
	ETD-25H15	7ETD.25H15.SS	ELEC	1500	750	1600	3.5 kW - MF	+30 / +90°C	256 kg.	220V / 50Hz.	480 lt.	
	ETD-25H18	7ETD.25H18.SS	ELEC	1800	750	1600	5.0 kW - MF	+30 / +90°C	296 kg.	220V / 50Hz.	580 lt.	
	ETD-25H20	7ETD.25H20.SS	ELEC	2000	750	1600	5.0 kW - MF	+30 / +90°C	351 kg.	220V / 50Hz.	640 lt.	

HOT
HOT
HOT
HOT
HOT

Neutral

	TYPE	CODE	MODEL	L	W	H	POWER	TEMP.	WEIGHT	VOLTAGE	CAPACITY	PRICE
	ETD-25N10	7ETD.25N10.SS	ELEC	1000	750	1600	0.05 kW - MF	-	179 kg.	220V / 50Hz.	320 lt.	
	ETD-25N12	7ETD.25N12.SS	ELEC	1200	750	1600	0.05 kW - MF	-	199 kg.	220V / 50Hz.	390 lt.	
	ETD-25N15	7ETD.25N15.SS	ELEC	1500	750	1600	0.05 kW - MF	-	254 kg.	220V / 50Hz.	480 lt.	
	ETD-25N18	7ETD.25N18.SS	ELEC	1800	750	1600	0.06 kW - MF	-	294 kg.	220V / 50Hz.	580 lt.	
	ETD-25N20	7ETD.25N20.SS	ELEC	2000	750	1600	0.06 kW - MF	-	349 kg.	220V / 50Hz.	640 lt.	

NOTR
NOTR
NOTR
NOTR
NOTR



ETD-35C10
Wall Type Self Service
Display Unit
COLD

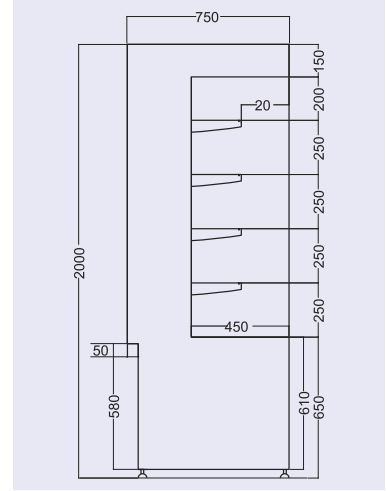

Cold

TYPE	CODE	MODEL	L	W	H	POWER	TEMP.	WEIGHT	VOLTAGE	CAPACITY	PRICE
ETD-35C10	7ETD.35C10.SS	ELEC	1000	750	2000	0.75 kW - MF	+4 / +6 °C	190 kg.	220V / 50Hz.	490 lt.	
ETD-35C12	7ETD.35C12.SS	ELEC	1200	750	2000	1.3 kW - MF	+4 / +6 °C	225 kg.	220V / 50Hz.	590 lt.	
ETD-35C15	7ETD.35C15.SS	ELEC	1500	750	2000	1.3 kW - MF	+4 / +6 °C	285 kg.	220V / 50Hz.	740 lt.	
ETD-35C18	7ETD.35C18.SS	ELEC	1800	750	2000	1.3 kW - MF	+4 / +6 °C	340 kg.	220V / 50Hz.	880 lt.	
ETD-35C20	7ETD.35C20.SS	ELEC	2000	750	2000	1.3 kW - MF	+4 / +6 °C	375 kg.	220V / 50Hz.	980 lt.	

COLD
COLD
COLD
COLD
COLD

Hot

TYPE	CODE	MODEL	L	W	H	POWER	TEMP.	WEIGHT	VOLTAGE	CAPACITY	PRICE
ETD-35H10	7ETD.35H10.SS	ELEC	1000	750	2000	5 kW - MF	+30 / +90 °C	181 kg.	220V / 50Hz.	490 lt.	
ETD-35H12	7ETD.35H12.SS	ELEC	1200	750	2000	5 kW - MF	+30 / +90 °C	201 kg.	220V / 50Hz.	590 lt.	
ETD-35H15	7ETD.35H15.SS	ELEC	1500	750	2000	5 kW - MF	+30 / +90 °C	256 kg.	220V / 50Hz.	740 lt.	
ETD-35H18	7ETD.35H18.SS	ELEC	1800	750	2000	7 kW - MF	+30 / +90 °C	296 kg.	220V / 50Hz.	880 lt.	
ETD-35H20	7ETD.35H20.SS	ELEC	2000	750	2000	7 kW - MF	+30 / +90 °C	351 kg.	220V / 50Hz.	980 lt.	

HOT
HOT
HOT
HOT
HOT

Neutral

TYPE	CODE	MODEL	L	W	H	POWER	TEMP.	WEIGHT	VOLTAGE	CAPACITY	PRICE
ETD-35N10	7ETD.35N10.SS	ELEC	1000	750	2000	0.05 kW - MF	-	190 kg.	220V / 50Hz.	490 lt.	
ETD-35N12	7ETD.35N12.SS	ELEC	1200	750	2000	0.05 kW - MF	-	225 kg.	220V / 50Hz.	590 lt.	
ETD-35N15	7ETD.35N15.SS	ELEC	1500	750	2000	0.05 kW - MF	-	285 kg.	220V / 50Hz.	740 lt.	
ETD-35N18	7ETD.35N18.SS	ELEC	1800	750	2000	0.06 kW - MF	-	340 kg.	220V / 50Hz.	880 lt.	
ETD-35N20	7ETD.35N20.SS	ELEC	2000	750	2000	0.06 kW - MF	-	375 kg.	220V / 50Hz.	980 lt.	

NOTR
NOTR
NOTR
NOTR
NOTR